

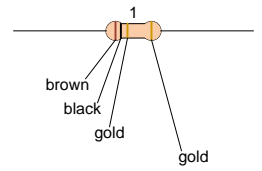







Parts List 1

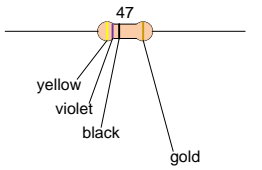

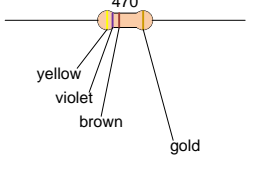
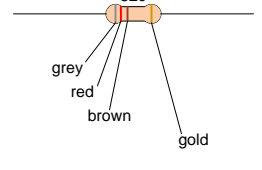
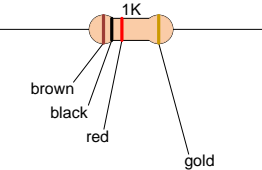

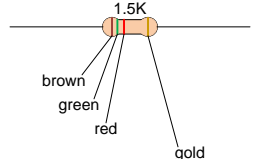
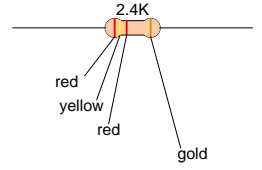
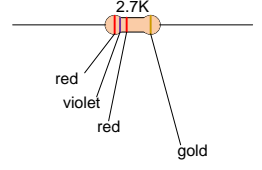
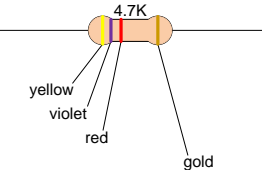

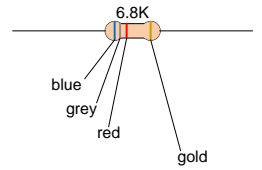
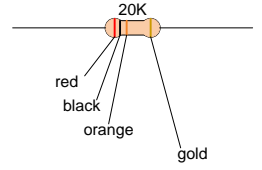
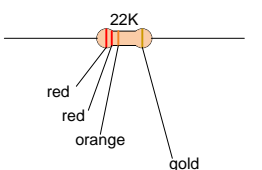
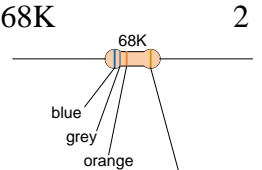
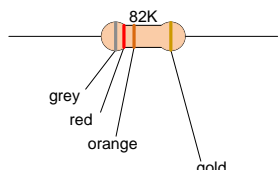
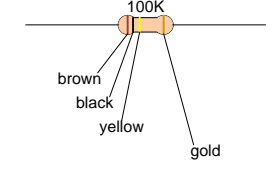
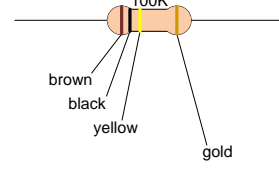
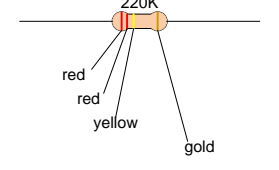
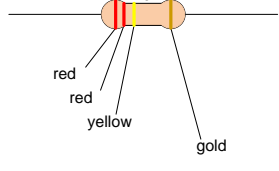
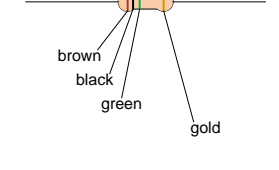
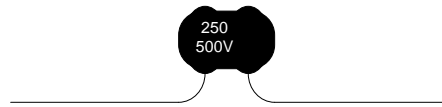
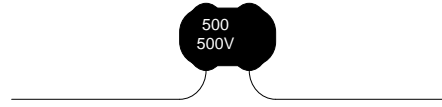
R-A1	2	1Ω, ½W resistor
		BAG 6
R-Q1	1	1Ω, 5W resistor
		BAG 7
R-A47	1	47Ω, ½W resistor
		BAG 6
R-R360	1	360Ω, 10W resistor
		BAG 7
R-A470	3	470Ω, ½W resistor
		BAG 6
R-A820	2	820Ω, ½W resistor
		BAG 6
R-B1K	1	1kΩ, 1W resistor
		BAG 6
R-Q1K	2	1kΩ, 5W resistor
		BAG 7
R-A1D5K	2	1.5kΩ, ½W resistor
		BAG 6

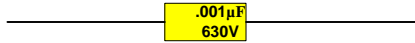

R-A2D4K	1	2.4kΩ, ½W resistor
		BAG 6
R-A2D7K	1	2.7kΩ, ½W resistor
		BAG 6
R-B4D7K	1	4.7kΩ, 1W resistor
		BAG 6
R-Q5K	1	5kΩ, 5W resistor
		BAG 7
R-A6D8K	2	6.8kΩ, ½W resistor
		BAG 6
R-A20K	1	20kΩ, ½W resistor
		BAG 6
R-A22K	1	22kΩ, ½W resistor
		BAG 6
R-A68K	2	68kΩ, ½W resistor
		BAG 6

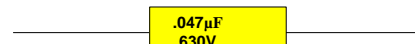
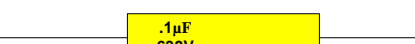

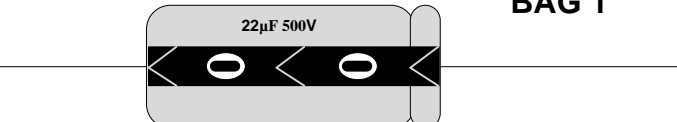
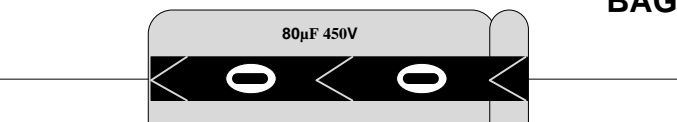
R-B82K	1	82kΩ, 1W resistor
		BAG 6
R-A100K	1	100kΩ, ½W resistor
		BAG 6
R-B100K	3	100kΩ, 1W resistor
		BAG 6
R-A220K	2	220kΩ, ½W resistor
		BAG 6
R-B220K	2	220kΩ, 1W resistor
		BAG 6
R-A1M	4	1MΩ, ½W resistor
		BAG 6

C-SM250	1	250pF capacitor
		BAG 1
C-SM500	1	500pF capacitor
		BAG 1

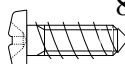
Parts List 2



C-MD001-630	1	0.001 μ F capacitor
		BAG 1
C-MD022-630	2	0.022 μ F capacitor
		BAG 1
C-MD047-630	1	0.047 μ F capacitor
		BAG 1
C-MD1-630	4	0.1 μ F capacitor
		BAG 1
C-ET22-50	2	22 μ F polarized capacitor
		BAG 1
C-ET22-500-IL	4	22 μ F polarized capacitor
		BAG 1
C-ET80-450-IL	2	80 μ F polarized capacitor
		BAG 1
C-ET220-50	1	220 μ F polarized capacitor
		BAG 1



S-HS832-34	4	#8 screw
		BAG 10
S-HST8-12	8	#8 self-tap screws
		
S-HHN832	4	#8 hex nut
		

S-HS632-14	22	#6 screw
		BAG 8
S-HLW6	20	#6 lock washer
		



S-H112	4	#6 locking lug
		BAG 10

S-HHN632	22	#6 hex nut
		BAG 8

S-HS440-14	4	#4 screw
		BAG 9
S-HLW4	4	#4 lock washer
		
S-HHN440	4	#4 hex nut
		

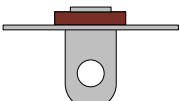
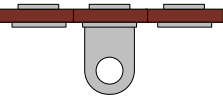
S-HS1032-12	8	#10 screw
		BAG 9
S-HLW10	6	#10 lock washer
		
S-HHN1032	8	#10 hex nut
		

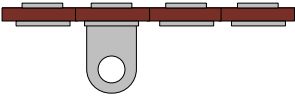
P-0300V	5	3 lug vertical terminal strip (no common lugs)
		BAG 2
		T10, T11, T12, T13, T14
P-0301H	1	3 lug terminal strip (2 nd lug common)
		
		T9

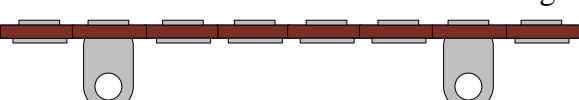
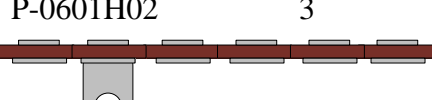
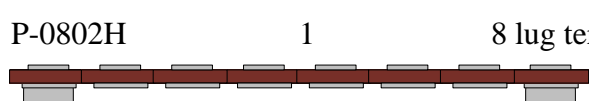
P-0401H	2	4 lug terminal strip (2 nd lug common)
		BAG 2
		T2, T6
P-0500H	1	5 lug terminal strip (no common lugs)
		
		T7
P-0600H	2	6 lug terminal strip (no common lugs)
		
		T3, T4
P-0601H02	3	6 lug terminal strip (2 nd lug common)
		
		T5, T'5, T8
P-0802H	1	8 lug terminal strip (1 st and 8 th lug common)
		
		T1

P-T374BX 1 power transformer (TR1)

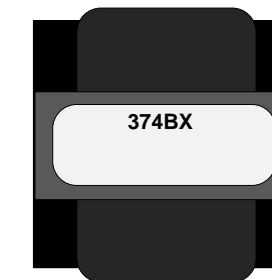

P-T1650P 1 output transformer (TR2)



Parts List 3

T-12AX7-S-JJ 1 12AX7/ECC83 preamp tube
BAG 5



T-12AT7-JJ 1 12AT7/ECC81 preamp tube

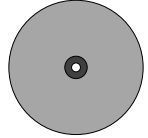

T-6L6GC-JJ-MP 1 matched pair of 6L6GC power tubes

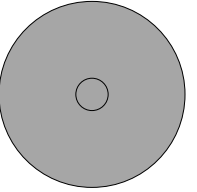

T-EL34-JJ-MP 1 matched pair of EL34 power tubes



P-Q1N4007 3 solid state diode
BAG 6

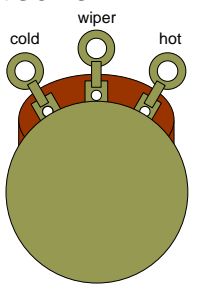
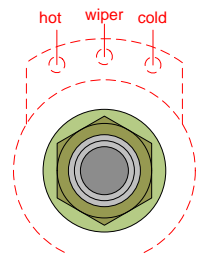

R-V38-25KL 1 25kΩ potentiometer (linear taper)
BAG 3

P-K300 4 black chicken head knobs
BAG 4

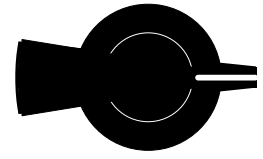

P-H1600 1 impedance selector switch and output jack
BAG 5

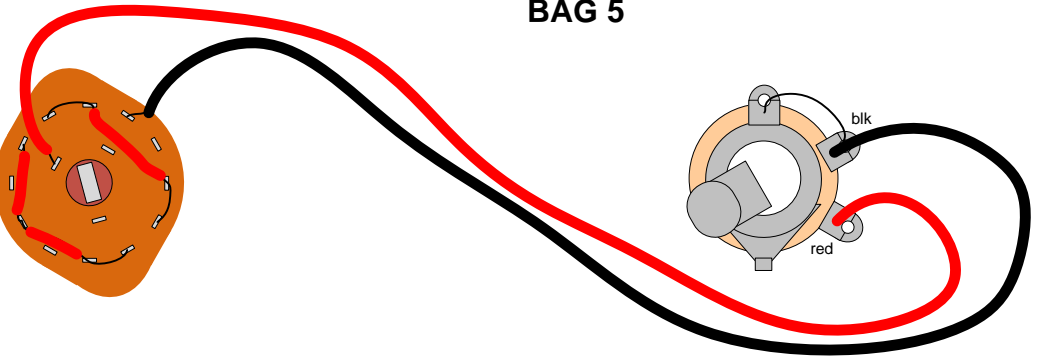

S-H142 2 tube clip
BAG 4

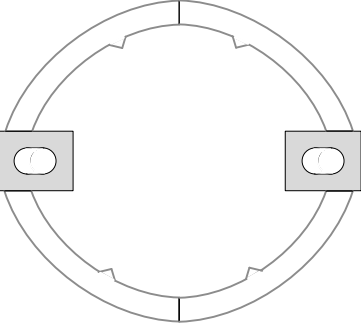

P-G005 5 rubber grommet
BAG 4



P-H1200 1 Strain Relief
BAG 4

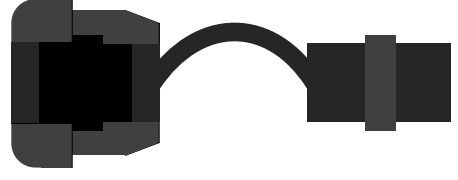

S-H33-097 1 input jack
BAG 4

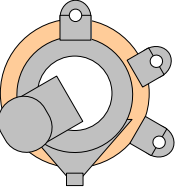

R-V38-250KA 2 250kΩ potentiometer (audio taper)
BAG 3

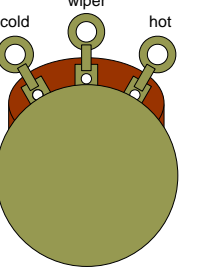
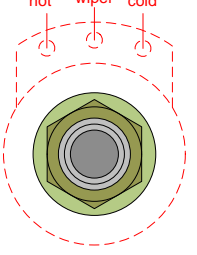
R-V38-1MA 1 1MΩ potentiometer (audio taper)

P-ST9-700 2 nine pin miniature tube socket
BAG 5

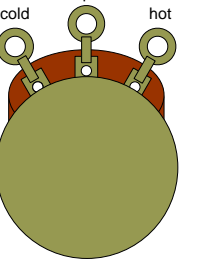
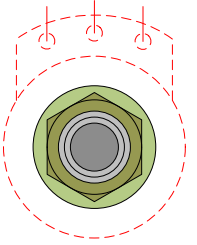

P-ST8-807 2 octal tube socket
BAG 5

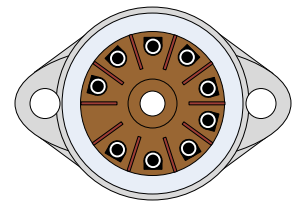

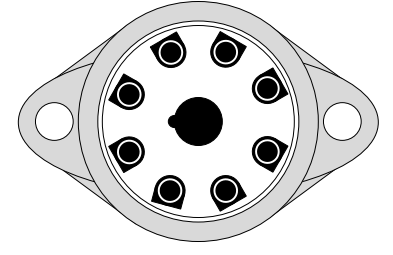
P-L121 1 purple jewel
BAG 4

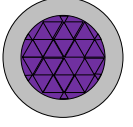

P-H35-146 1 power switch (DPDT)
BAG 5

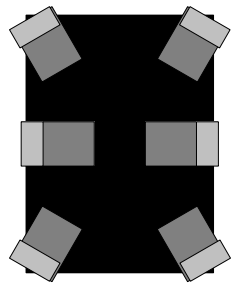
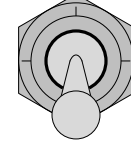
Parts List 4

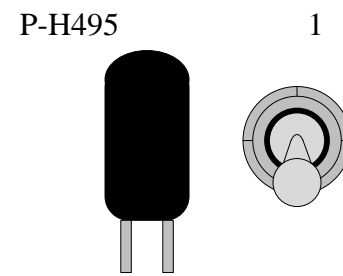

P-H495 1 standby switch (SPST)
BAG 5

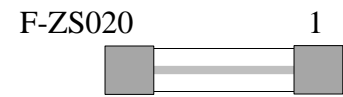

F-ZS020 1 fuse (2A Slow Blow)
BAG 4

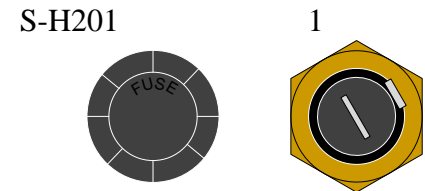

S-H201 1 fuse holder
BAG 4

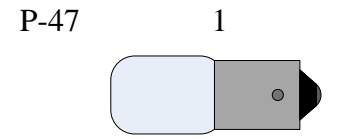

P-47 1 bulb/lamp (bayonet base)
BAG 4

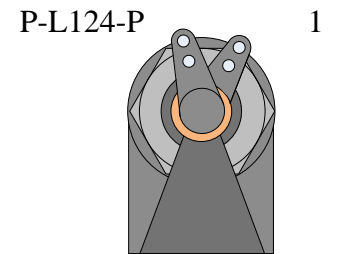

P-L124-P 1 lamp holder
BAG 5

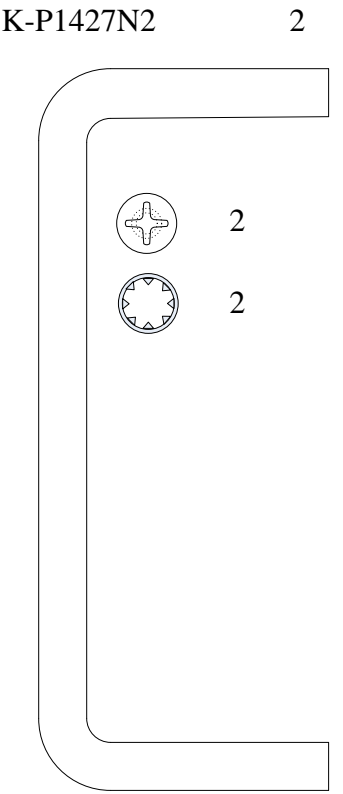

K-P1427N2 2 handle
BAG 5

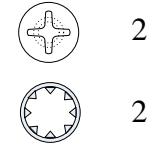

2 #8 screw



2 #8 lock washer

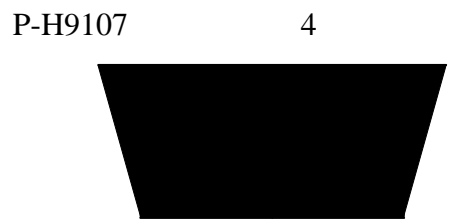

P-H9107 4 rubber feet
BAG 5

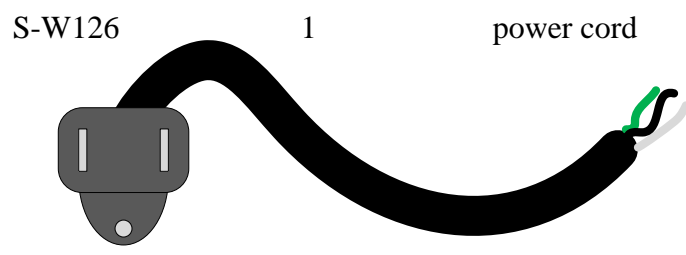

S-W126 1 power cord

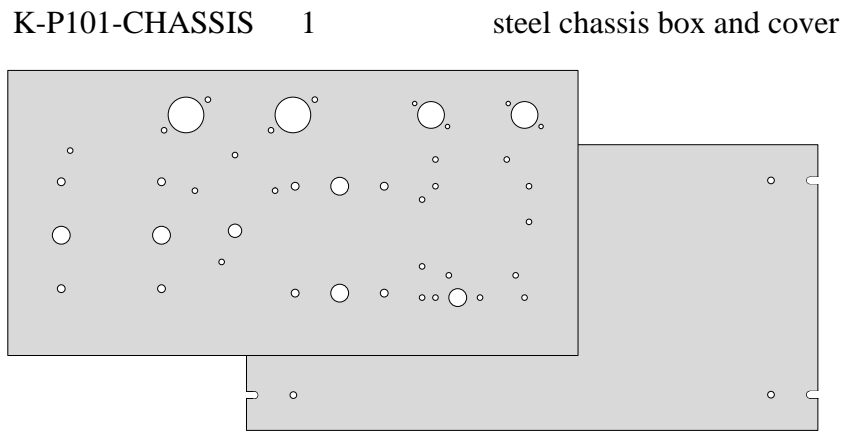

K-P101-CHASSIS 1 steel chassis box and cover

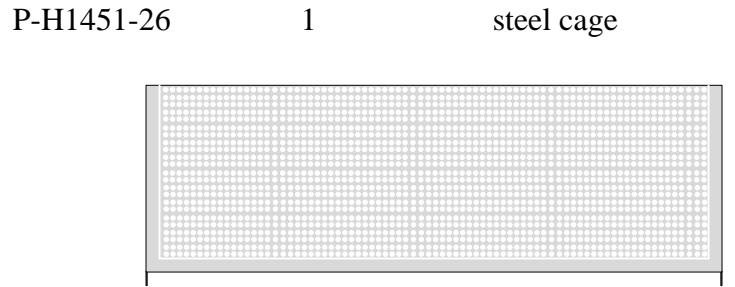

P-H1451-26 1 steel cage

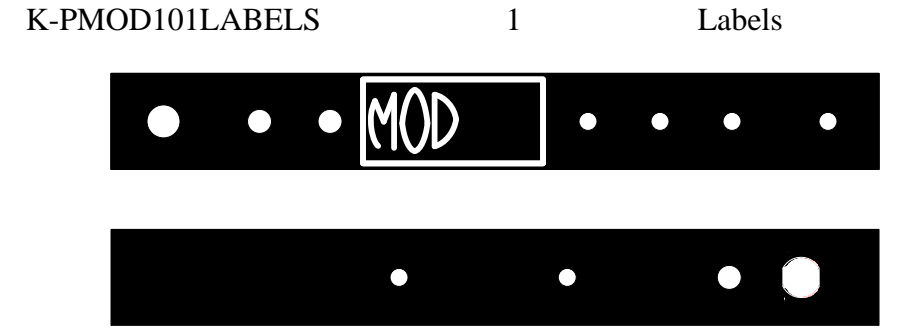

K-PMOD101LABELS 1 Labels



CARDBOARD TUBE

S-W707L 1 10 ft of 20 AWG wire (green)
BAG 5

S-W22R 1 20 ft of 22 AWG wire (red)
BAG 5