

THE CONTORTIONIST II (K-965)

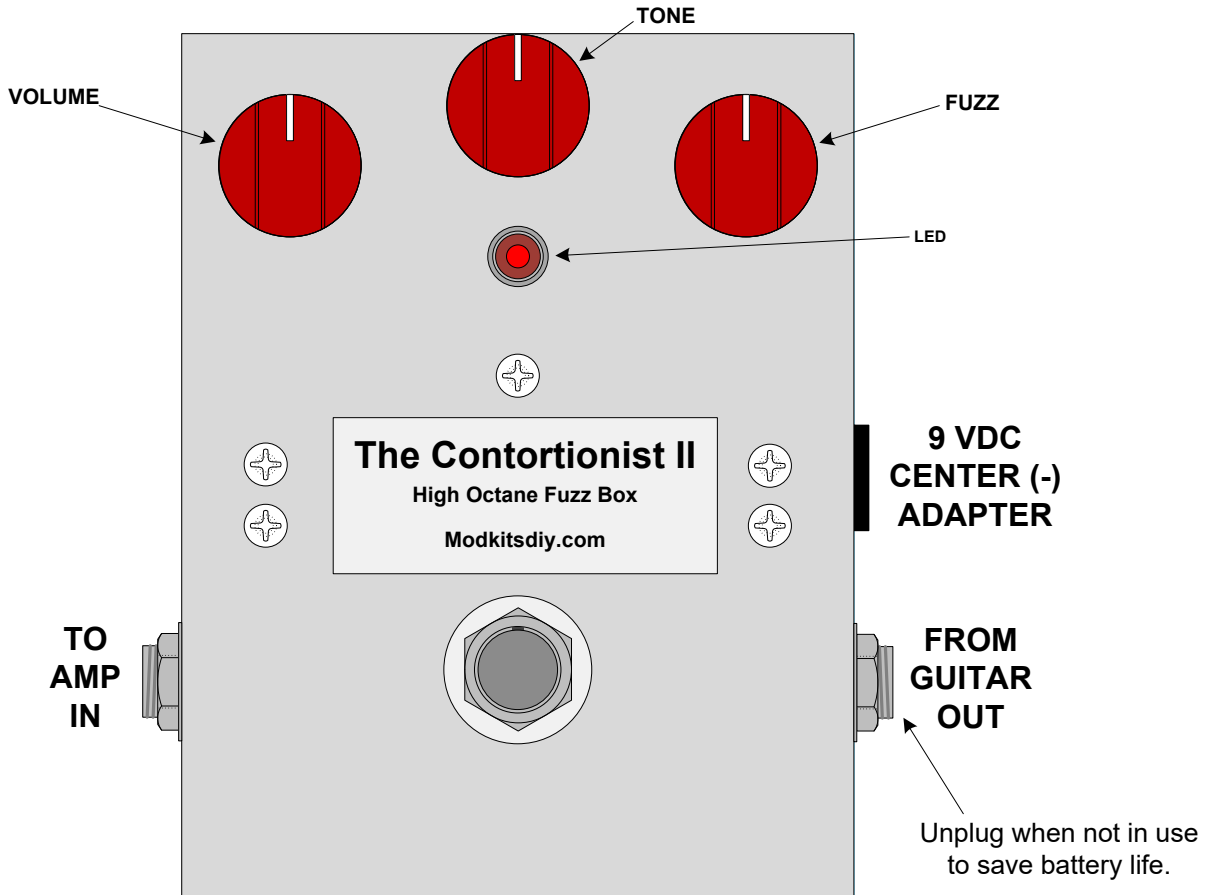

Use these instructions to learn:

- How to build an effects pedal for fuzz with non-selective frequency tripler.

The Contortionist II kit is an all analog, high octane fuzz box. It produces fuzz with layered octave overtones similar to those produced by an electronic-bow. The frequency multiplier circuitry creates harmonics that swell and recede depending on gain setting, pick attack, neck position and pickup. This is a high gain circuit that can put out up to 2 volts and will provide ample amounts of sustain.

Added features to the original contortionist circuit include a tone control and LED.

Warning: This circuit was designed for use with a 9 VDC power supply only.

MOD[®]
www.modkitsdiy.com

TABLE OF CONTENTS

TOOL LIST	p. 2
PARTS LIST DRAWINGS	pp. 3, 4
FINAL ASSEMBLY REFERENCE DRAWING	p. 5
SOLDERING TIPS	p. 6
STEP BY STEP ASSEMBLY INSTRUCTIONS	pp. 7 - 11
Section 1 - Mount Large Components	p. 7
Section 2 - Wire Large Components	p. 7
Section 3 - Mount Components to Terminal Strips	p. 8
Section 4 - Finishing Up	p. 10
<u>ASSEMBLY DRAWINGS (4 Drawings)</u>	pp. 11 - 12

These are the last 2 pages. They can be used as a reference for assembly.

Visit www.modkitsdiy.com if you have any problems when first turning on your pedal for troubleshooting help. Remember to use caution when applying power to the pedal to avoid electric shock.

TOOL LIST

- Wire Strippers
- Needle Nose Pliers
- Cutting Pliers
- Desoldering Pump
- Solder (60/40 rosin core)
- Soldering Station
- Phillips Head Screwdrivers
- Slotted tip screwdrivers (3 mm tip)
- Channellock Pliers (or similar type)
- Ruler
- Hobby Vise (or other means to secure box while working)

PARTS LIST 1

Stranded Wire (22 AWG) - Blue
K-PUL1569-BLUE (4 FT)

Enclosure
P-H1590BBCE-GY (1)

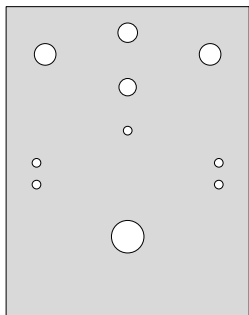

Wine Red Knob with White Line
P-K380WN (3)

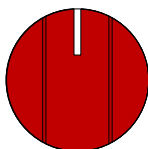

Battery Clip
S-H155 (1)

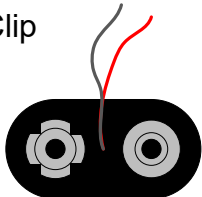

1/4" Mono Jack (Output Jack)
W-SC-11 (1)

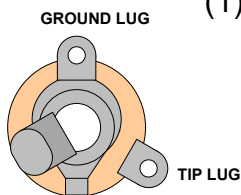

1/4" Stereo Jack (Input Jack)
W-SC-12B (1)

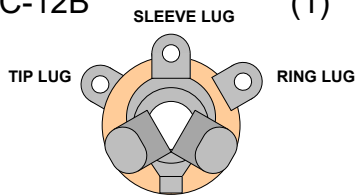

DC Power Jack
S-H750 (1)



3PDT Foot Switch
P-H501 (1)



Potentiometers (24 mm diameter)
R-VA1KL (1)
R-VA250KA (1)

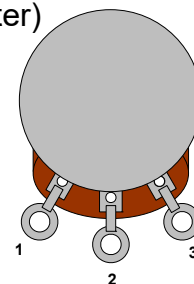

Mini Potentiometer (16 mm diameter)
R-VAM100KA-SS (1)

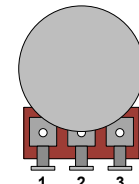

Terminal Strip with 8 Terminals
P-0802H (2)

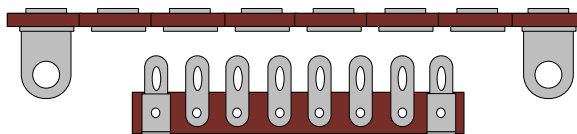

Terminal Strip with 3 Terminals
P-0301H (1)

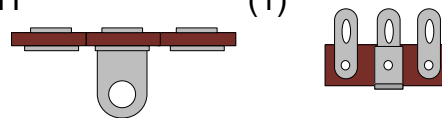

#4 Screw (3/8" long)
S-HS440-38 (5)



#4 Nut
S-HHN440 (5)



#4 Lock Washer
S-HLW4 (5)



PARTS LIST 2

NPN Darlington (MPSA13)
P-QMPSA13 (1)

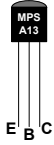

NPN BJT (2N3904TAR)
K-P2N3904TAR (1)

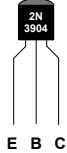

PNP BJT (2N3906)
K-PQ-2N3906 (1)

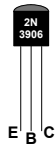

22 μ F Polarized Capacitor 50V
C-ET22-50 (1)



0.0039 μ F Capacitor 100V
C-PEID0039-100 (1)



0.1 μ F Capacitor 100V
C-PEID1-100 (2)



0.22 μ F Capacitor 100V
C-PEID22-100 (1)

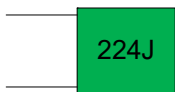

330pF Capacitor 3kV
C-D330-3000 (1)



180 Ω Resistor $\frac{1}{2}$ W
R-A180 (1)

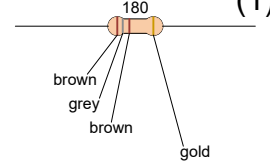

1.5k Ω Resistor $\frac{1}{2}$ W
R-A1D5K (1)

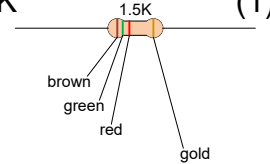

10k Ω Resistor $\frac{1}{2}$ W
R-A10K (3)

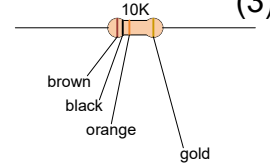

820k Ω Resistor $\frac{1}{2}$ W
R-A820K (1)

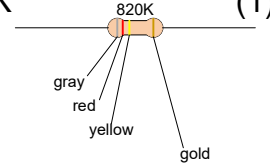

3M $\frac{1}{2}$ W
R-A3M (1)

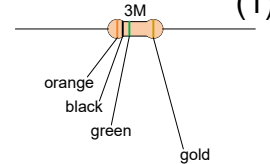

Light Emitting Diode
P-L400 (1)

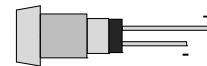

FINAL ASSEMBLY REFERENCE DRAWING

This is a large version of the final assembly drawing. Refer to this drawing as you make your way through each step of the instructions. Before you make a new connection at a particular terminal or solder lug, notice how many other connections will be made at that terminal. That way you can decide whether it's best for you to solder the connection and leave space open for future connections or hold off on soldering until after every connection at that location has been made.

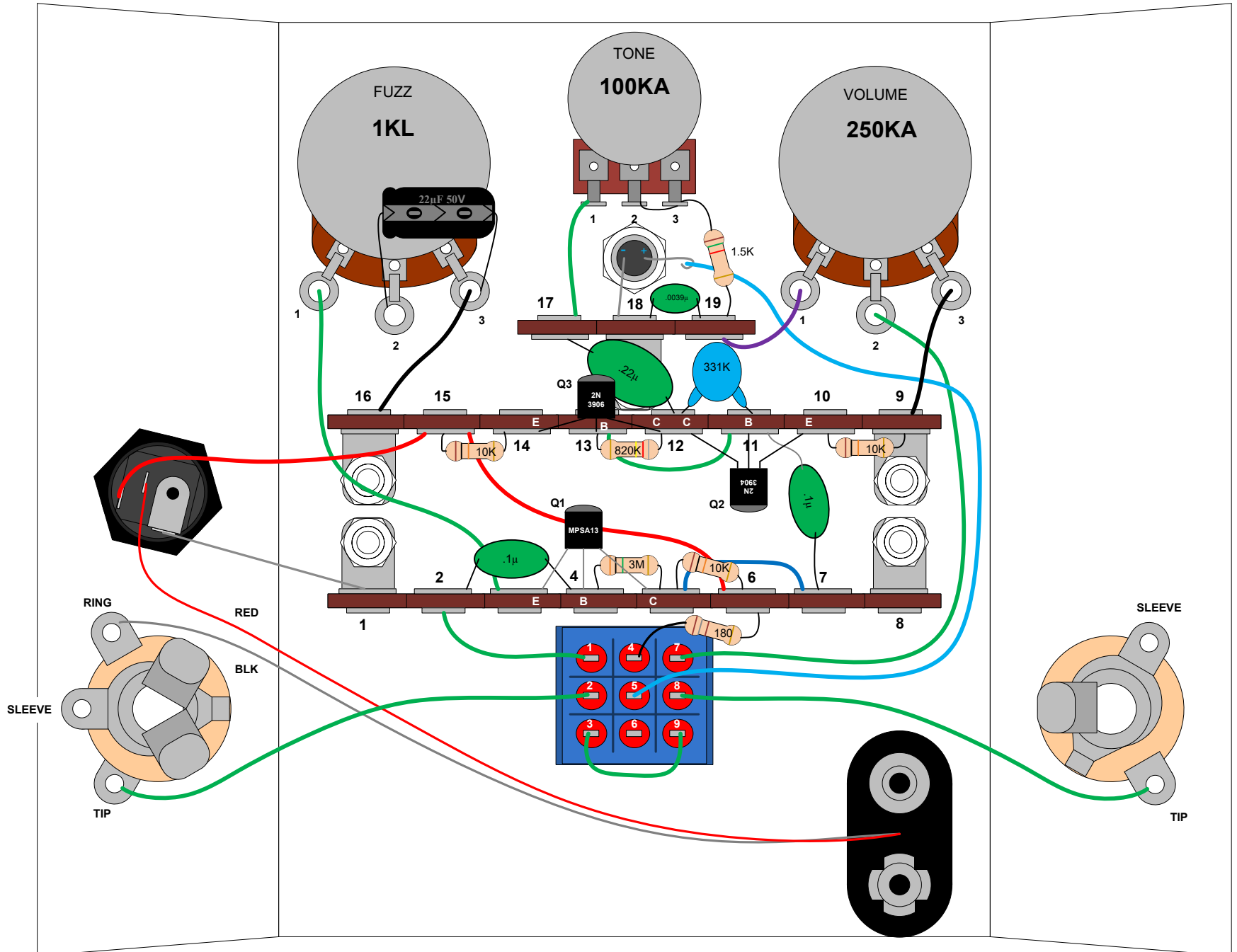

SOLDERING TIPS

It is important to make a good solder joint at each connection point. A cold solder joint is a connection that may look connected but is actually disconnected or intermittently connected. (A cold solder joint can keep your project from working.)

Follow these tips to make a good solder joint. *Take your time with each connection and make sure that all components are connected and will remain connected if your project is bumped or shaken.*

1. Bend the component lead or wire ending and wrap it around the connection point.
 - Make sure it is not too close to a neighboring component which could cause an unintended connection.
2. Wrap the component lead so that it can hold itself to the connection point.
3. Touch the soldering iron to both the component lead and the connection point allowing both to warm up just before applying the solder to them.
4. Be sure to adequately cover both component lead and connection point with melted solder.
 - Remove the soldering iron from your work and allow the solder joint to cool. (The solder joint should be shiny and smooth after solidifying.)
 - Cut off any excess wire or component leads with cutting pliers.
 - Clean the soldering iron's tip by wiping it across the wet sponge again after making the solder joint.

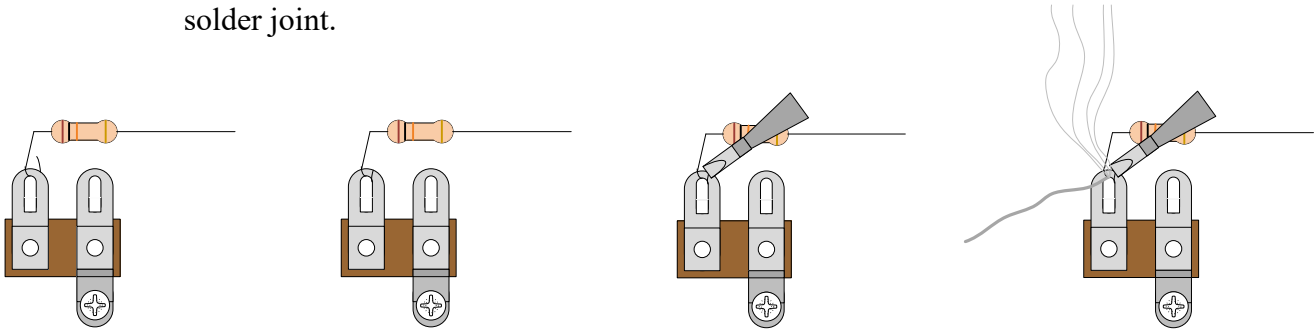

1. Bend the component lead and wrap it around the connection point.

2. Wrap the component lead so that it can hold itself to the connection point.

3. Heat up both component lead and connection point with the soldering iron.

4. Apply solder to both component lead and connection point.

De-Soldering Tip

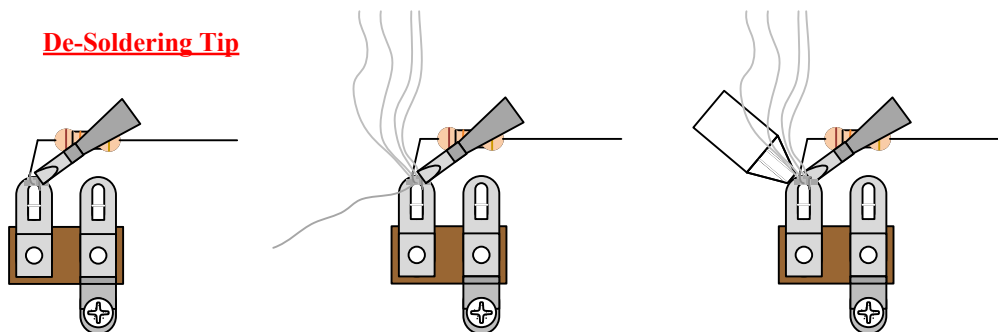

1. Heat up old solder joint with the soldering iron.

2. Apply fresh solder to mix in with old solder joint

3. Use a de-soldering tool to remove the old solder joint while it is heated.

SECTION 1 – Mount Large Components

Please refer to **DRAWING 1** and **DRAWING 2**.

Orient the enclosure with the two 5/16" holes and one 9/32" hole on top.

Mount the LED and bezel holder in the 1/4" hole. Align the LED leads so its anode (positive lead) is closer to the right side of the enclosure as shown in Drawing 2.

The Anode (+) side of the LED is indicated by a slightly longer lead and/or a positive sign.

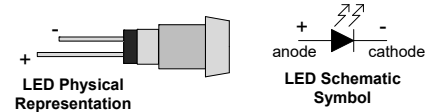

Using the five screws, nuts and lock washers provided, fasten the three terminal strips to match **DRAWING 2**.

Fasten the 3 lug terminal strip first. Then fasten the two 8 lug terminal strips.

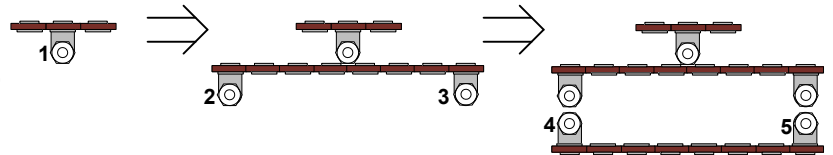

Mount the 1KL pot in the 5/16" hole on the left and the 250KA pot in the other 5/16" hole on the right. Mount the mini 100KA pot in the 9/32" hole at the top center.

- *Bend back and remove the alignment tab on the top of each potentiometer using a pair of pliers before mounting the pots so that they can mount flush against the enclosure surface.*

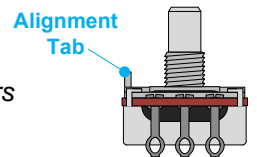

Mount the DC power jack in the 15/32" hole on the left side of the enclosure. Orient its solder lugs similar to how they are shown in Drawing 2.

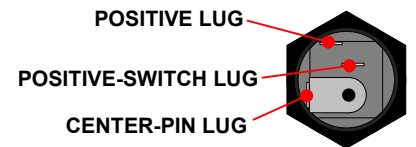

Mount the input jack in the 3/8" hole on the left side of the enclosure with the hardware provided. The washer goes under the nut on the outside of the enclosure. Make sure the center solder lug of the input jack is facing up. Correct positioning of the jack makes soldering the connections easier.

Mount the output jack in the 3/8" hole on the right side of the enclosure. Make sure the two solder lugs are in their most upright position before tightening the nut.

Mount the footswitch in the 15/32" hole in the center of the enclosure. The nylon washer goes under the mounting nut on the outside of the enclosure. The lock washer mounts on the inside between the enclosure surface and the other nut. Make sure the footswitch is oriented to match **DRAWING 2**.

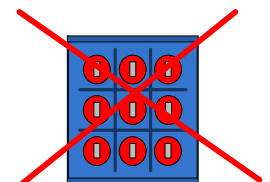

Incorrect Orientation

SECTION 2 – Wire Large Components

Please refer to **DRAWING 3**.

Stripping wire, tinning wire and soldering. Throughout these instructions you will be told to strip and tin a length of wire numerous times. Unless noted otherwise, cut the wire to the length stated in the instructions. Then strip 1/4" of insulation off each end. Twist each end of the stranded wire, and apply a small amount of solder to each end (i.e. tin the wire ends). This will prevent the stranded wire from fraying and will make the final soldering much easier.

Tip: Some terminals will have three or more wire/component connections which can make it difficult to find room for everything that needs to be connect to that terminal. In this case, we will provide a warning and suggest connecting wires to the lower terminal holes.

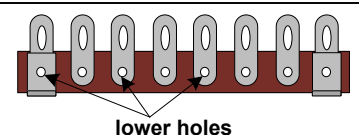

When connecting wires to lower terminal holes, just be sure that the exposed wire end is resting against the metal of the terminal while adding solder. Hold the wire in place for a few seconds while the connection cools. After cooling, tug on the wire slightly to ensure it is secured to the lower terminal hole.

Please note that each terminal has been numbered as illustrated here and will be referred to as a "terminal #_" when connecting different components and wires throughout the assembly instructions.

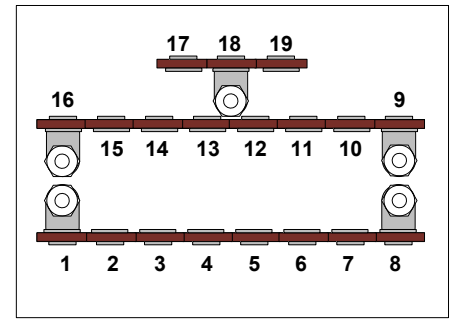

- Strip and tin a 2" piece of wire and connect footswitch lug 8 to the output jack's tip lug.
- Strip and tin a 1 ½" piece of wire and connect footswitch lugs 3 and 9.
- Strip and tin a 2" piece of wire and connect footswitch lug 2 to the input jack's tip lug.
- Strip and tin a 4 ½" piece of wire and connect footswitch lug 7 to 250K "volume" pot lug 2.
- Strip and tin a 1 ¾" piece of wire and connect footswitch lug 1 and terminal #2.
- Strip and tin a 5 ½" piece of wire and connect footswitch lug 5 to the anode (+) lead of the LED.

Tip: Form a hook in both the LED's lead and the wire-end. Hook them to each other and press the hooks closed together. Apply solder after the LED lead and wire-end are tightly hooked to each other.

- Connect the cathode (-) lead of the LED to terminal #18.

Tip: You may need to bend terminal #18 down toward the cathode lead or add a short wire to make this connection.

- Strip and tin a 2 ½" piece of wire and connect terminal #6 to #15.

Suggestion: 3 wires/components will be connected to these terminals. Consider connecting to the lower terminal holes.

- Strip and tin a 2 ½" piece of wire and connect terminal #3 and 1K "fuzz" pot lug 1.

- Strip and tin a 1" piece of wire and connect terminal #15 to the power jack's "positive" lug.

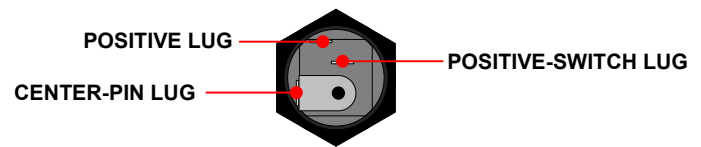

- Strip and tin a 1 ½" piece of wire and connect terminal #5 to #7.

Suggestion: 4 wires/components will be connected to terminal #5 and #11 in the next step. Consider connecting to the lower terminal holes.

- Strip and tin a 1 ½" piece of wire and connect terminal #11 to #13.

- Strip and tin a 1 ½" piece of wire and connect terminal #16 and 1K pot lug 3.

Tip: Leave room at lug 3 for a capacitor lead connected later.

- Strip and tin a 1" piece of wire and connect terminal #9 and 250K pot lug 3.

- Strip and tin a 1 ½" piece of wire and connect terminal #17 and 100K "tone" pot lug 1.

- Strip and tin a 1" piece of wire and connect terminal #19 to 250K pot lug 1.

- Strip about ¾" of insulation off one end of the remaining wire. Twist and tin this end. When cool, cut off this piece of wire. Connect one end to the power jack's center-pin lug and the other end to terminal #1.

SECTION 3 – Mount Components to Terminal Strips

Please refer to **DRAWING 4**.

Connect and solder all the following components to their respective terminals as listed. *(Make sure that none of the component leads are so close together that it could cause an unintended short).*

Unless noted otherwise, "connect" means to trim the component's leads to a reasonable length, wrap them tightly around their connection points and solder. (See "Soldering Tips" on page 6).

- Connect the 0.1 μ F cap to terminals #2 and #4. This should be mounted upside down to allow room for other components to be mounted later in the instructions. There will be two more components connected to terminal #4 so **do not solder at #4, yet.**
- Connect the 3M resistor to terminals #4 and #5. This resistor should be pushed down to allow room for other components to be mounted later in the instructions. **Do not solder at #5, yet.**
- Connect a 10K resistor to terminals #5 and #6. **Do not solder at #5, yet.**
- Connect the MPSA13 transistor to terminals #3, #4 and #5 as listed below. **Solder all of the connections at these terminals now.**

Terminals #3: Emitter

Terminals #4: Base

Terminals #5: Collector

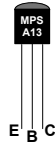

- Connect the 0.1 μ F cap to terminals #7 and #11. This should be mounted upside down to allow room for other components to be mounted later in the instructions. **Do not solder at #11, yet.**

- Connect a 10K resistor to terminals #9 and #10. **Do not solder at #10, yet.**

- Connect the 2N3904 transistor to terminals #10, #11 and #12 as listed below. **Solder all of the connections at these terminals now.**

Terminals #10: Emitter

Terminals #11: Base

Terminals #12: Collector

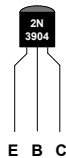

- Connect the 2N3906 transistor to terminals #12, #13 and #14 as listed below. **Solder all of the connections at these terminals now.**

Terminals #12: Collector

Terminals #13: Base

Terminals #14: Emitter



- Connect the remaining 10K resistor to terminals #14 and #15.
- Connect the 330pF cap to terminals #11 and #12.
- Connect the 820K resistor to terminals #12 and #13.
- Connect the 0.22 μ F cap to terminals #12 and #17. Mount this cap upside down.

- Connect the positive (+) lead of the 22 μ F cap to 1K pot lug 2 and connect the negative (-) side to 1K pot lug 3. Mount it so that its leads are not at risk of shorting out against the pot's body.



- Connect one end of the 1.5K resistor to both lugs 2 and 3 of the 100K "tone" pot. Connect the other end to terminal #19.

- Connect the .0039 μ F cap to terminals #18 and #19.

- Connect the 180 Ω resistor from terminal #6 to footswitch lug 4.

- Locate the battery snap connector. Connect its red wire to the power jack's "positive switch" lug and connect its black wire to the input jack's ring lug

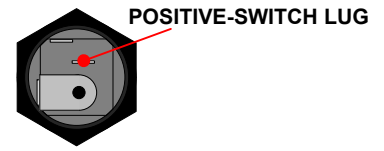

SECTION 4 – Finishing Up

It's always a good idea to thoroughly double-check your connections before applying power. This will minimize the risk of damaging components.

- Fasten the knobs to the potentiometer shafts by tightening their set screws. Install a 9 volt battery if needed. Fasten the cover using the four screws provided. Plug your guitar into the input jack on the right side of the pedal. This turns power on when you are not using an AC adapter for power. Plug another cable from the output jack (left side) to your amp's input.
- When using a battery for power, remember to unplug from the input jack of the pedal to turn it off and save battery life.

If your pedal does not work properly, the first step is always to double-check your connections. If everything looks good, then e-mail info@modkitsdiy.com for troubleshooting help.

DRAWING 1

LEFT SIDE

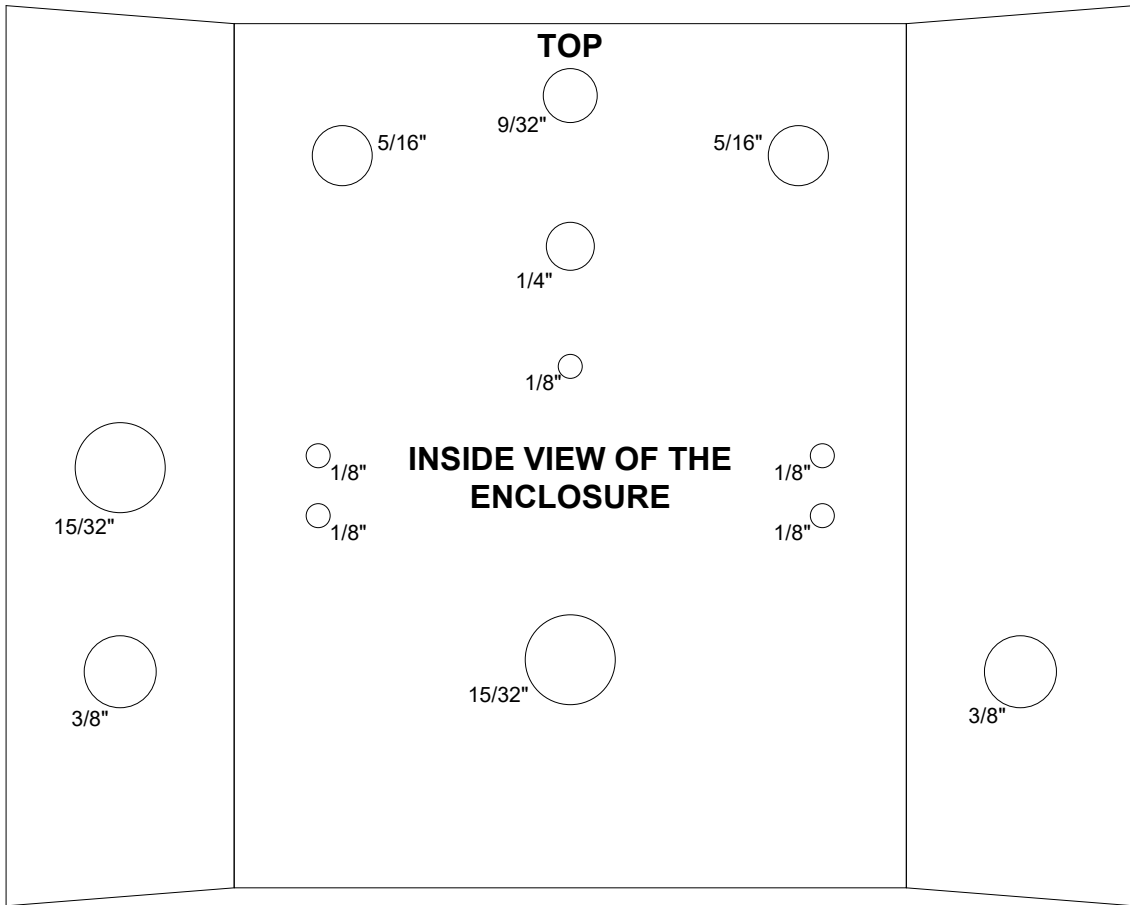

DRAWING 2

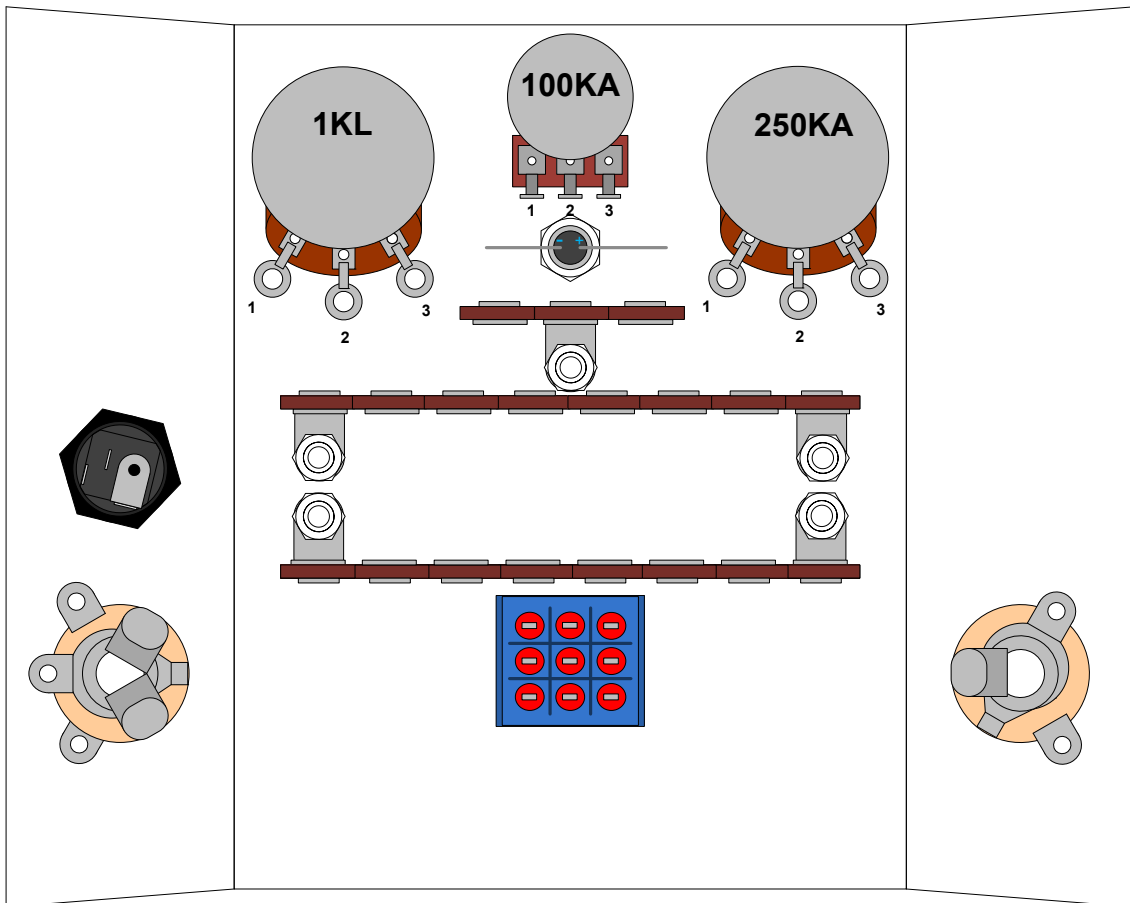

DRAWING 3

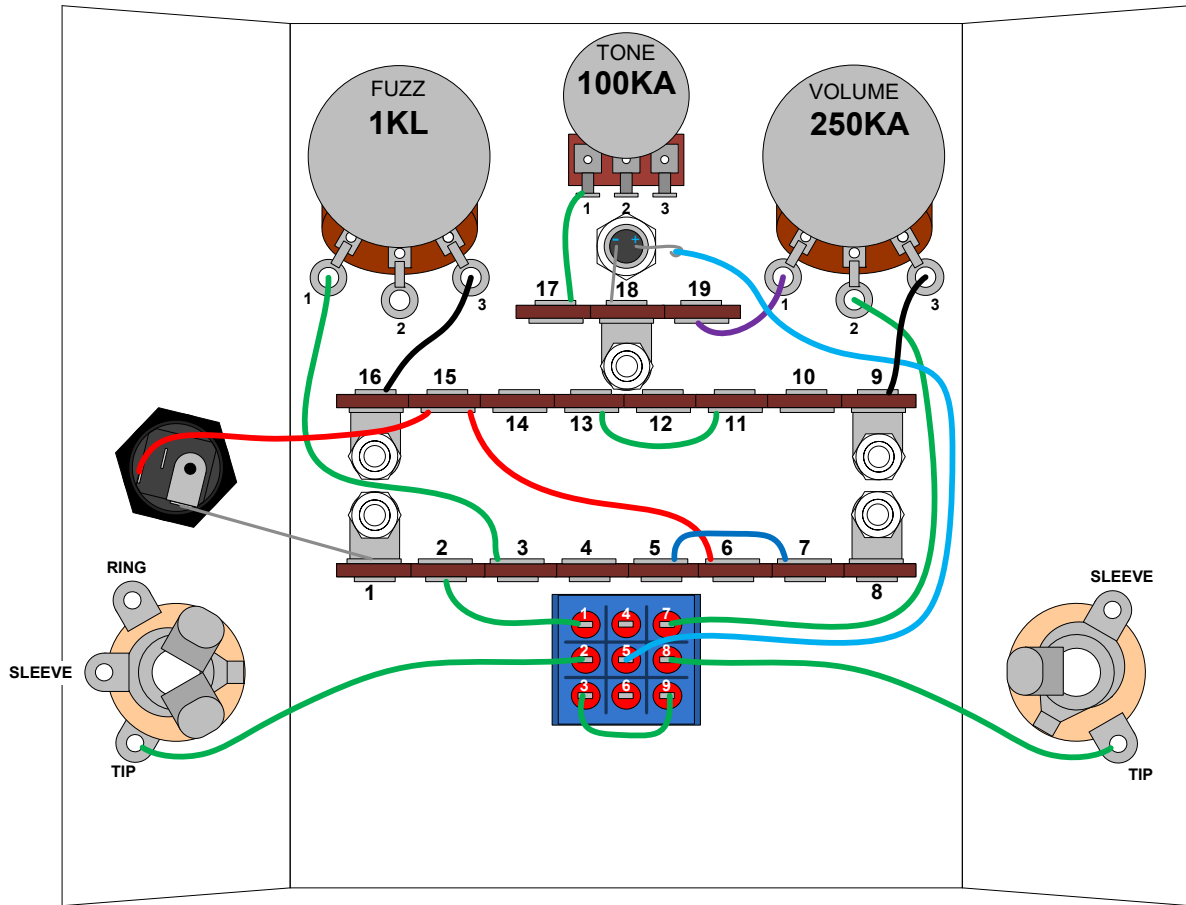

DRAWING 4

