

The Erratic Clutch Deluxe (K-997)



Use these instructions to learn:

- How to build an effects pedal for fuzzy synth/organ sounds.

The Erratic Clutch Deluxe is a unique effect pedal that gives you fuzzy square wave distortion as well as a monophonic sub-octave square wave using a total of only four transistors. The two signals can be used individually or mixed together for a raw synthy output. Full of character and quirk, this pedal will give you a truly original sound.

Warning: This circuit was designed for use with a 9 VDC power supply only.

MOD[®]
www.modkitsdiy.com

TABLE OF CONTENTS

TOOL LIST	2
PARTS LIST DRAWINGS	3-4
FINAL ASSEMBLY REFERENCE DRAWING	5
SOLDERING TIPS	6
STEP BY STEP ASSEMBLY INSTRUCTIONS	7-10
Section 1 (Drawings 1 & 2)	7
Section 2 (Drawing 3)	8
Section 3 (Drawing 4)	8-9
Section 4 (Drawing 5)	9
Section 5 (Drawing 6)	10
Section 6 (Drawing 7)	10
Section 7 (Drawing 8)	10
Section 8 (Finishing Up)	10
<u>ASSEMBLY DRAWINGS</u> (8 Drawings)	11-14
These are the last 4 pages. They should be separated and used as a reference to help assemble the kit correctly. Hi-res color versions available on modkitsdiy.com	

Visit www.modkitsdiy.com if you have any problems when first turning on your pedal for troubleshooting help. Remember to use caution when applying power to the pedal to avoid electric shock.

TOOL LIST

- Wire Strippers
- Needle Nose Pliers
- Hex Key (Allen Wrench)
- Cutting Pliers
- Desoldering Pump
- Solder (60/40 rosin core)
- Soldering Station
- Phillips Head Screwdrivers
- Slotted tip screwdrivers (3 mm tip)
- Channellock Pliers (or similar type)
- Ruler
- Hobby Vise (or other means to secure box while working)

PARTS LIST 1

Stranded Wire (22 AWG) - Red
 K-PUL1569 (3.5 FT)
 Enclosure
 P-H1590BBCE-BK (1)

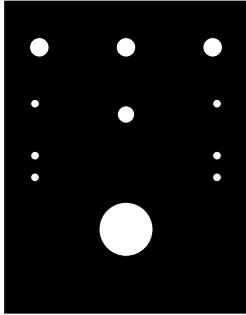

Knob (Black with Line)
 P-K345 (2)

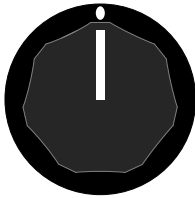

Knob (Black with Line)
 P-K344 (1)

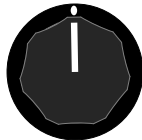

Terminal Strip with 8 Terminals
 P-0802H (3)

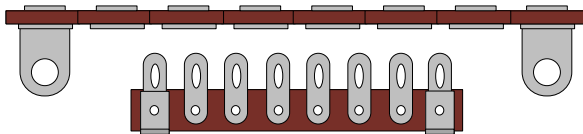

1/4" Mono Jack (Output Jack)
 W-SC-11 (1)

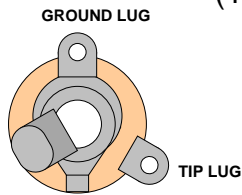

1/4" Stereo Jack (Input Jack)
 W-SC-12B (1)

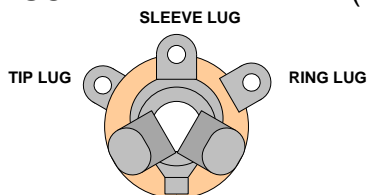

3PDT LED Foot Switch
 P-H590-RB (1)

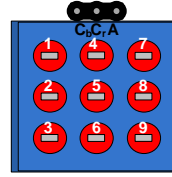

Potentiometers: 100KL and 100KA
 R-VAM100KL-SS (1)
 R-VAM100KA-SS (2)

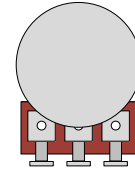

Battery Clip
 S-H155 (1)

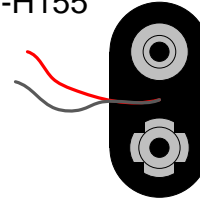

DPDT Mini Toggle Switch
 P-H542 (1)

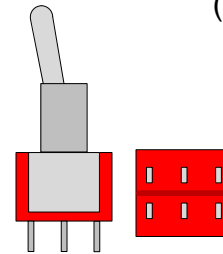

DC Power Jack
 S-H750 (1)



#4 Screw (1/4" long)
 S-HS440-14 (6)



#4 Nut
 S-HHN440 (6)



#4 Lock Washer
 S-HLW4 (6)



PARTS LIST 2

390Ω Resistor ½ W

R-A390 (1)

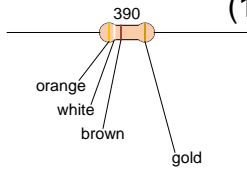

8.2kΩ Resistor ½ W

R-A8D2K (2)

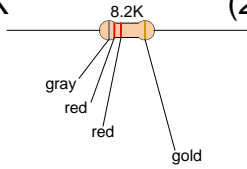

47kΩ Resistor ½ W

R-A47K (2)

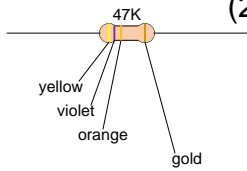

56kΩ Resistor ½ W

R-A56K (2)

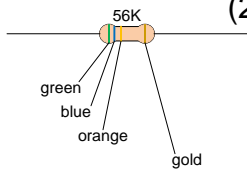

100kΩ Resistor ½ W

R-A100K (2)

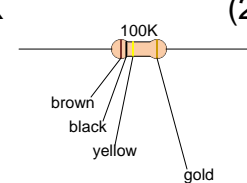

240kΩ Resistor ½ W

R-M240K (2)

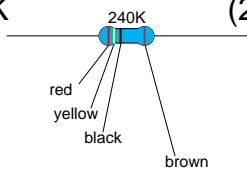

680kΩ Resistor ½ W

R-A680K (1)

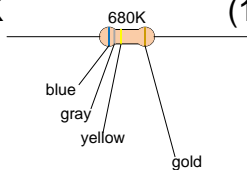

1MΩ Resistor ½ W

R-A1M (2)

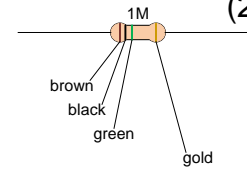

2MΩ Resistor ½ W

R-A2M (1)

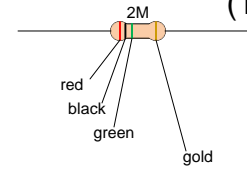

NPN BJT (2N5088)

P-Q2N5088 (4)

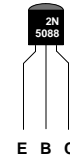

10μF Polarized Capacitor 50V

C-ET10-50 (2)



0.22μF Capacitor 100V

C-PEID22-100 (1)

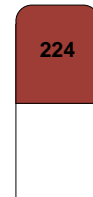

0.01μF Capacitor

C-PEID01-100 (2)

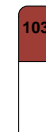

330pF Capacitor

C-D330-3000 (2)



1N4148 High Speed Diode

P-Q971 (2)



SOLDERING TIPS

It is important to make a good solder joint at each connection point. A cold solder joint is a connection that may look connected but is actually disconnected or intermittently connected. (A cold solder joint can keep your project from working.)

Follow these tips to make a good solder joint. *Take your time with each connection and make sure that all components are connected and will remain connected if your project is bumped or shaken.*

1. Bend the component lead or wire ending and wrap it around the connection point.
 - Make sure it is not too close to a neighboring component which could cause an unintended connection.
2. Wrap the component lead so that it can hold itself to the connection point.
3. Touch the soldering iron to both the component lead and the connection point allowing both to warm up just before applying the solder to them.
4. Be sure to adequately cover both component lead and connection point with melted solder.
 - Remove the soldering iron from your work and allow the solder joint to cool. (The solder joint should be shiny and smooth after solidifying.)
 - Cut off any excess wire or component leads with cutting pliers.
 - Clean the soldering iron's tip by wiping it across the wet sponge again after making the solder joint.

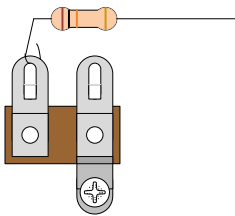

1. Bend the component lead and wrap it around the connection point.

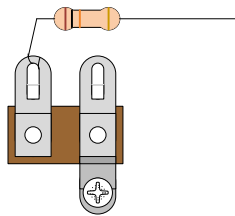

2. Wrap the component lead so that it can hold itself to the connection point.

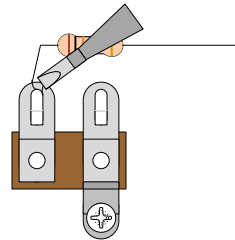

3. Heat up both component lead and connection point with the soldering iron.

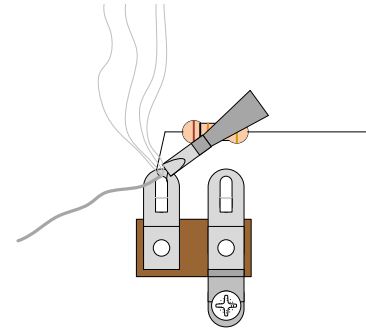

4. Apply solder to both component lead and connection point.

De-Soldering Tip

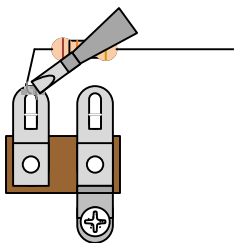

1. Heat up old solder joint with the soldering iron.

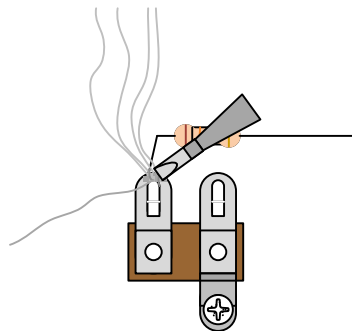

2. Apply fresh solder to mix in with old solder joint

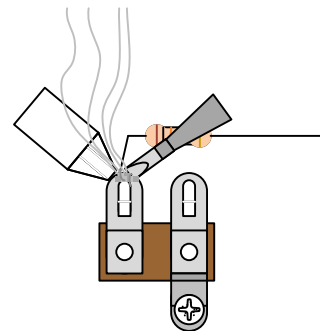

3. Use a de-soldering tool to remove the old solder joint while it is heated.

****This build guide uses a lot of right angle bends. This is so the instructions are not only legible but it also helps to keep leads from shorting since multiple components will be stacked on top of each other. The right angles are not necessary as long as you make sure that no leads are shorted.****

SECTION 1

Please refer to DRAWING 1 and DRAWING 2.

Orient the box with $\frac{3}{4}$ " hole nearest you.

- Bend back and remove the alignment tab on the top of each potentiometer using a pair of pliers before mounting the pots so that they can mount flush against the enclosure surface.
- Mount one 100KA pot in the $\frac{9}{32}$ " hole on the top left side of the box. Make sure that all three lugs are facing down toward the bottom of the box. Fasten the nut and tighten.

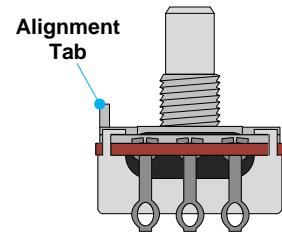

- Mount the 100KL pot in the $\frac{9}{32}$ " hole on the top center of the box. Make sure that all three lugs are facing down toward the bottom of the box. Fasten the nut and tighten.
- Mount the remaining 100KA pot in the $\frac{9}{32}$ " hole on the top right side of the box. Make sure that all three lugs are facing down toward the bottom of the box. Fasten the nut and tighten.

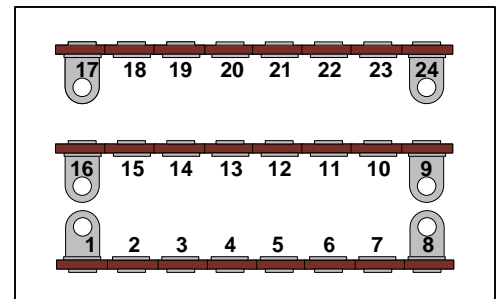

- Mount the 8 lug terminal strips to the $\frac{1}{8}$ " holes as shown in drawing 2 using the #4 screw nut and lock washer. The lock washer goes under the nut inside the chassis.

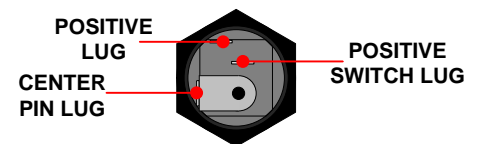

Be sure that no lugs are touching the sides of the box or other hardware added. We will refer to terminal numbers 1 through 24 as #1, #2, etc.

- Mount the DC power jack in the $\frac{15}{32}$ " hole on the left side of the enclosure. Orient its solder lugs so that the center-pin lug is facing the bottom side of the enclosure.
- Mount input jack in $\frac{3}{8}$ " hole on left side of box with hardware provided.

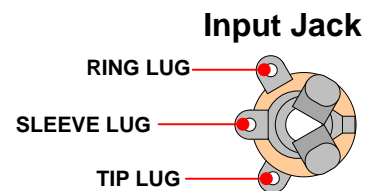

Washer goes under nut on outside of box. Make sure to orient the jack as shown in Drawing 2. When positioned correctly, tighten nut.

- Mount output jack in $\frac{3}{8}$ " hole on right side of box with hardware provided.
- Washer goes under nut on outside of box. Make sure to orient the jack as shown in Drawing 2. When positioned correctly, tighten nut.

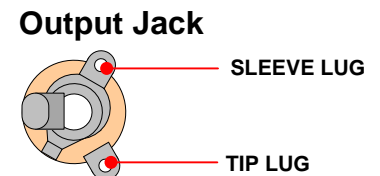

- Mount the LED footswitch to the $\frac{3}{4}$ " hole. Be sure to orient the LED leads towards the bottom with A on the left and C_b on the right.

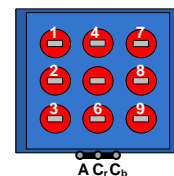

You must remove the button cap with a hex key before mounting.

- Mount the toggle switch in the remaining $\frac{1}{4}$ " hole. Orient it so that the switch moves left to right.

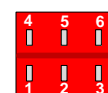

SECTION 2

Please refer to **DRAWING 3**.

- Strip and tin a $\frac{3}{4}$ " piece of wire and connect the lug 3 on the footswitch to lug 9 on the footswitch. **Solder both connections now.**
- Strip $\frac{1}{2}$ " of insulation off of the end of a piece of wire. First tin then snip the exposed wire from the rest of the wire. Use this piece to join lug 5 with lug 2 of the toggle switch. **Solder both connections now.**
- Strip and tin a $6\frac{1}{2}$ " piece of wire and connect lug 7 of the footswitch to the wire joining 2 and 5 of the toggle switch. **Solder the connection at lug 7 of the footswitch as well as the connection at the toggle switch now.**
- Strip and tin a $1\frac{3}{4}$ " piece of wire and connect #21 to #24 using the bottom holes for both connections. **Solder the connection at #21 now.**
- Strip and tin a $1\frac{1}{2}$ " piece of wire and connect #3 to #15 using the bottom holes for both connections. **Solder both connections now.**
- Strip and tin a $1\frac{1}{2}$ " piece of wire and connect #13 to #20 using the bottom holes for both connections. **Solder the connection at #20 now.**
- Strip and tin a 5" piece of wire and connect #2 to lug 2 of the 100KL pot using the bottom hole for the connection at #2. **Solder both connections now.**
- Strip $\frac{3}{4}$ " of insulation off of the end of a piece of wire. First tin then snip the exposed wire from the rest of the wire. Use this piece to connect the center-pin of the DC power jack to #1. **Solder the center pin connection now.**
- Connect an 8.2k resistor from #14 to #13 using the bottom holes for both connections. **Solder the connection at #14 now.**
- Connect a 100k resistor from #13 to #11 using the bottom holes for both connections.
- Connect the 390 ohm resistor from #4 to #13 using the bottom holes for both connections. **Solder the connection at #4 now.**

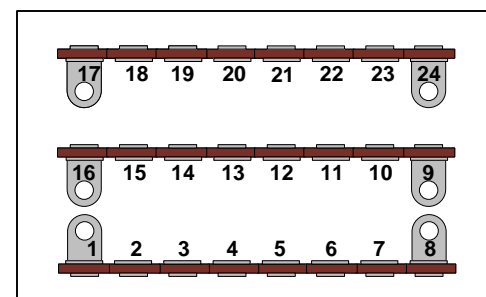
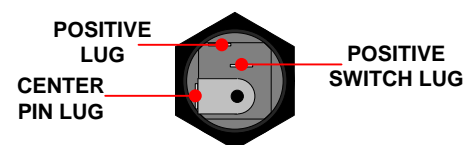
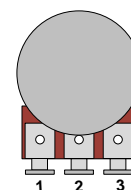
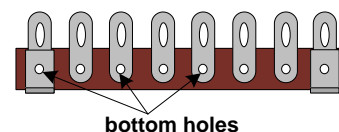
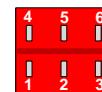
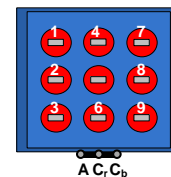

SECTION 3

Please refer to **DRAWING 4**.

- Strip and tin a 2" piece of wire and connect the C_r of the footswitch to the sleeve lug of the input jack. **Solder both connections now.**
- Strip and tin a 2" piece of wire and connect lug 2 of the footswitch to the input jack's tip lug. **Solder both connections now.**
- Strip and tin a 2" piece of wire and connect lug 8 of the footswitch to the output jack's tip lug. **Solder both connections now.**
- Strip and tin a $1\frac{1}{4}$ " piece of wire and connect lug 4 of the footswitch to #4. **Solder both connections now.**

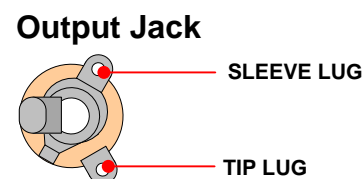
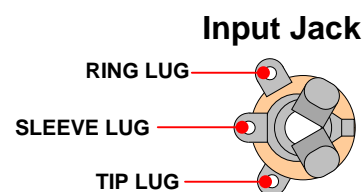

- Strip and tin a 2 ½” piece of wire and connect the positive lug of DC power jack to bottom hole at #13. **Solder the both connections now.**
- Connect a 56k resistor from #7 to #11 using the bottom holes for both connections. **Solder both connections now.**
- Connect a 56k resistor from #6 to #10 using the bottom holes for both connections. **Solder both connections now.**
- Strip ½” of insulation off of the end of a piece of wire. First tin then snip the exposed wire from the rest of the wire. Use this piece to join lug 3 of the left 100KA pot to bottom hole of #17. **Solder both connections now.**
- Strip ½” of insulation off of the end of a piece of wire. First tin then snip the exposed wire from the rest of the wire. Use this piece to join lug 3 of the right 100KA pot to the bottom hole of #24. **Solder both connections now.**
- Connect the 2M resistor from #20 to lug 1 of the 100KL pot. **Solder both connections now.**
- Connect a 240k resistor from #21 to lug 3 of the 100KL pot. **Solder both connections now.**
- Connect a 10uF capacitor from #14 to #19. Be sure to orient the capacitor so that the negative lead is connected to #19 and the positive to #14.
- Connect a 10uF capacitor from #11 to #22. Be sure to orient the capacitor so that the negative lead is connected to #22 and the positive to #11.

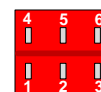
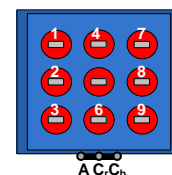
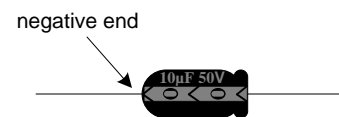
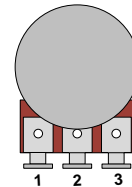
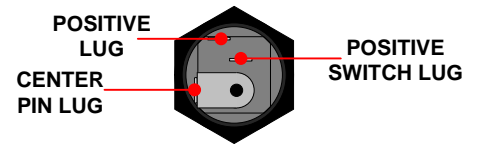

SECTION 4

Please refer to DRAWING 5.

- Strip and tin a ¾” piece of wire and connect lug 5 of the footswitch to the A pin of the footswitch. **Solder both connections now.**
- Connect the 0.22µF capacitor from #2 to lug 1 of the footswitch. **Solder the connection at lug 1 of the footswitch now.**
- Connect an 8.2k resistor from #3 to #13.
- Connect a 100k resistor from #6 to #13. **Solder the connection at #13 now.**
- Connect a 47k resistor from #18 to lug 3 of the toggle switch. **Solder the connection at lug 3 of the toggle switch now.**
- Connect a 47k resistor from #23 to lug 4 of the toggle switch. **Solder the connection at lug 4 of the toggle switch now.**
- Strip and tin a 1” piece of wire and connect #18 to lug 2 of the left 100KA pot. **Solder both connections now.**
- Strip and tin a 1” piece of wire and connect #23 to lug 2 of the right 100KA pot. **Solder both connections now.**

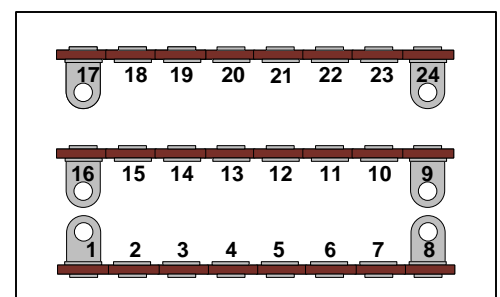

SECTION 5

Please refer to DRAWING 6.

- Connect a 330pF capacitor from #7 to #11.
- Connect a 330pF capacitor from #6 to #10. Be careful not to short these two capacitors.
- Connect the 680k resistor from #19 to lug 1 of the left 100KA pot. **Solder both connections now.**
- Connect a 240k resistor from #22 to lug 1 of the right 100KA pot. **Solder both connections now.**

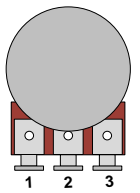

SECTION 6

Please refer to DRAWING 7.

- Connect a 2N5088 transistor to #1, #2, and #3. Make sure the flat side of the transistor is facing up with the body pointing towards the pots. The orientation *must* match drawing 7. **Solder connections on #1, #2, and #3 now.**
- Connect a 0.01μF capacitor from #5 to #14.
- Connect a 0.01μF capacitor from #14 to #12.
- Connect a 1M resistor from #5 to #6.
- Connect a 1M resistor from #12 to #11.
- Connect a 2N5088 transistor to #11, #10, and #9. Make sure the flat side of the transistor is facing up with the body pointing towards the footswitch. The orientation *must* match drawing 7. **Solder connections on #11 and #9 now.**

#1: Emitter
#2: Base
#3: Collector

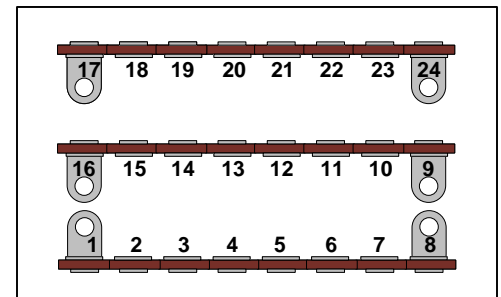
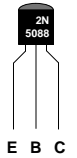

#9: Emitter
#10: Base
#11: Collector

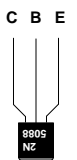

SECTION 7

Please refer to DRAWING 8.

- Connect a 2N5088 transistor to #16, #15, and #14. Make sure the flat side of the transistor is facing down with the body pointing towards the footswitch. The orientation *must* match drawing 8. **Solder connections on #16, #15, and #14 now.**
- Connect a diode from #5 to #7 with the black band connecting to #5. **Solder connection at #5 now.**
- Connect a diode from #12 to #10 with the black band connecting to #12. **Solder both connections now.**
- Connect a 2N5088 transistor to #6, #7, and #8. Make sure the flat side of the transistor is facing down with the body pointing towards the pots. The orientation *must* match drawing 8. **Solder connections on #6, #7, and #8 now.**
- Locate the battery clip. Connect the red wire to the positive-switch lug of the DC power jack. Connect the black wire to the ring lug of the input jack. **Solder both connections now.**

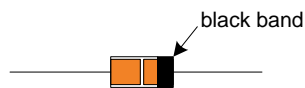

#16: Emitter
#15: Base
#14: Collector

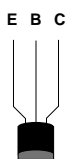

#6: Emitter
#7: Base
#8: Collector

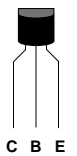

SECTION 8 Finishing Up

It's always a good idea to thoroughly double-check your connections before applying power.

Attach the knobs provided to the potentiometer shafts. Install a 9 volt battery, close the cover using the screws provided (battery not required when using 9v DC power supply). Plug a guitar into input jack on right. This turns the unit on. Plug a cable into output jack and plug it into your amplifier.

-Unplug from the input jack of the unit to turn it off and save power.

DRAWING 1

LEFT SIDE

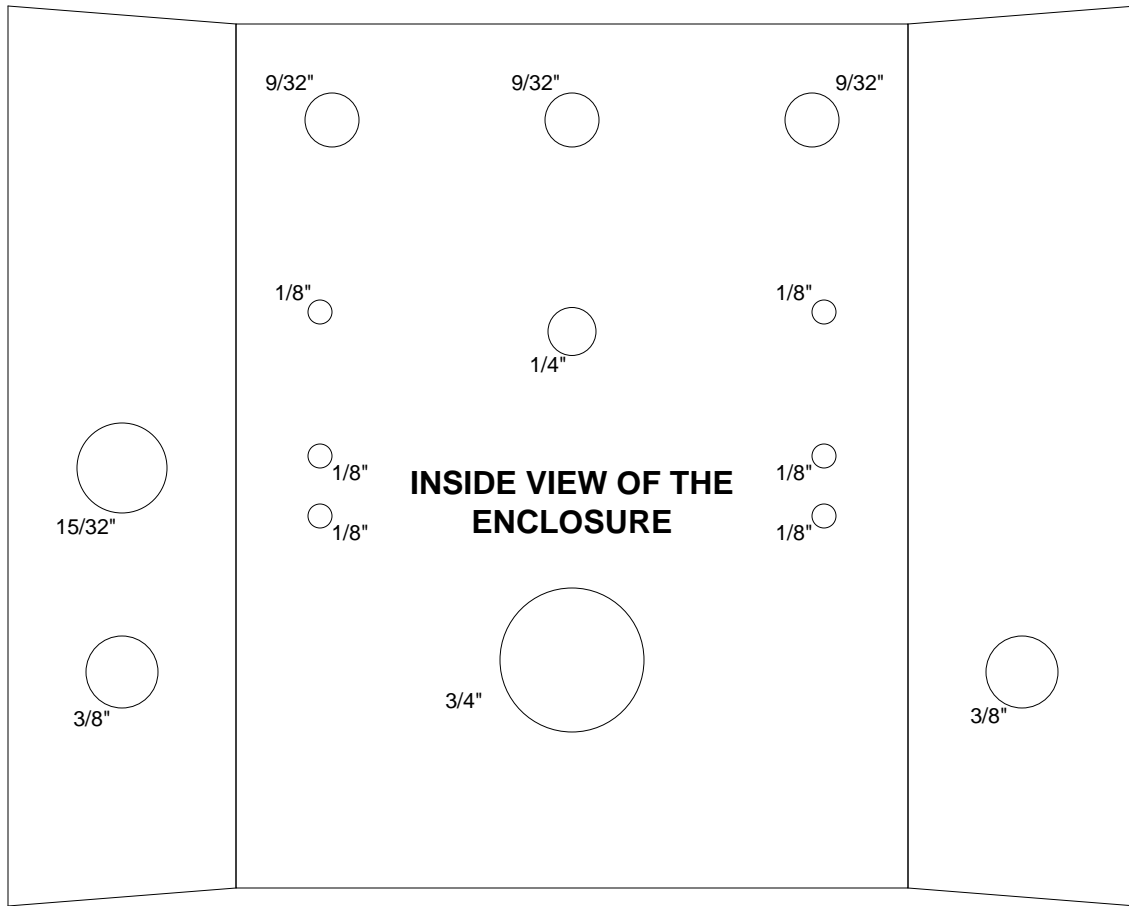

RIGHT SIDE

DRAWING 2

RING
SLEEVE
TIP

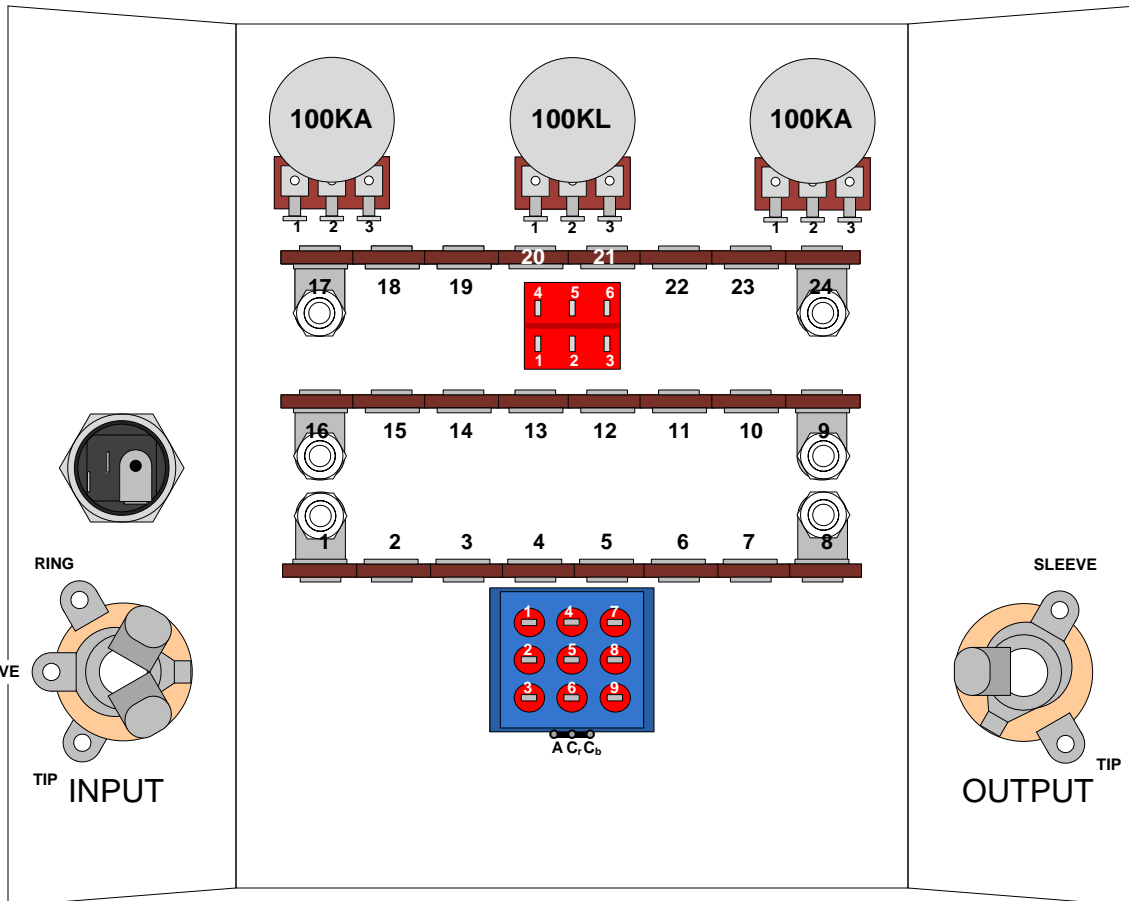

DRAWING 3

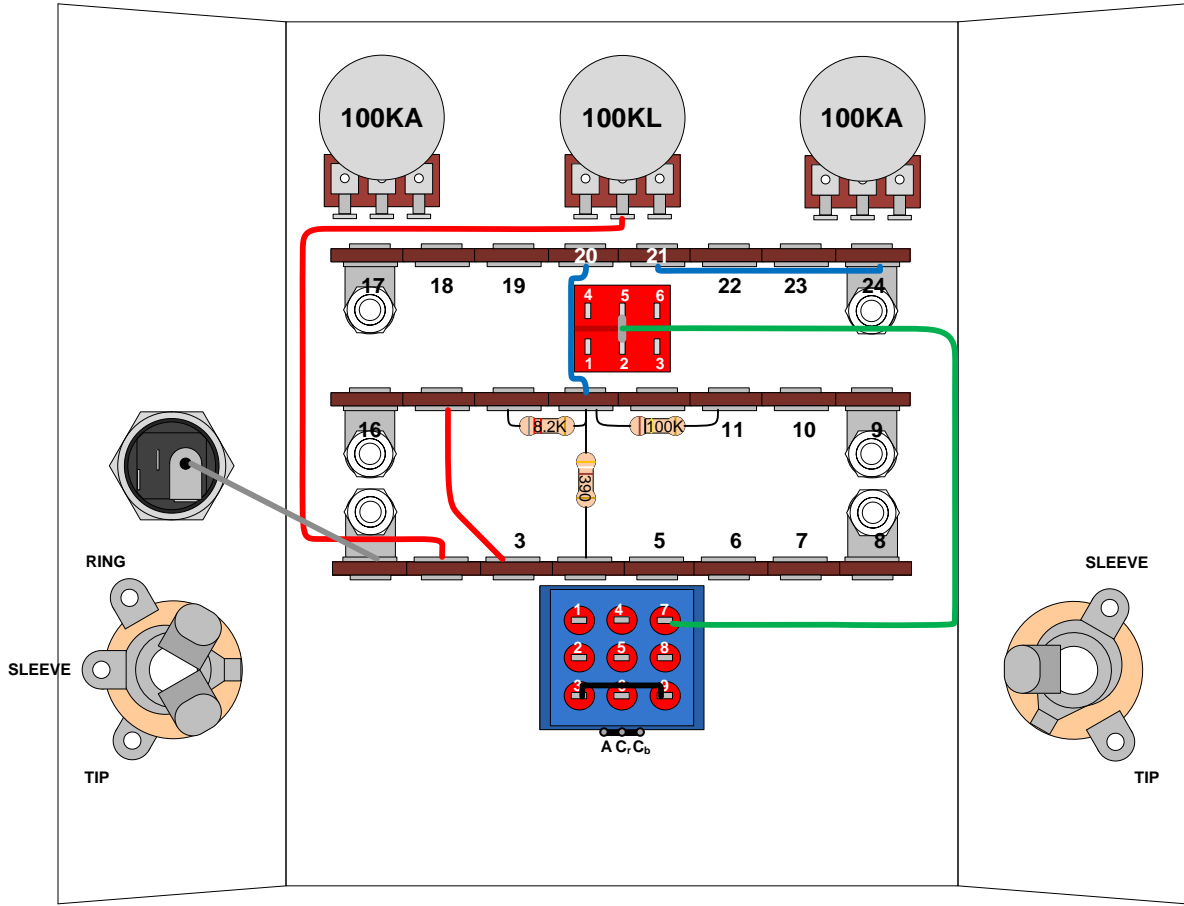

DRAWING 4

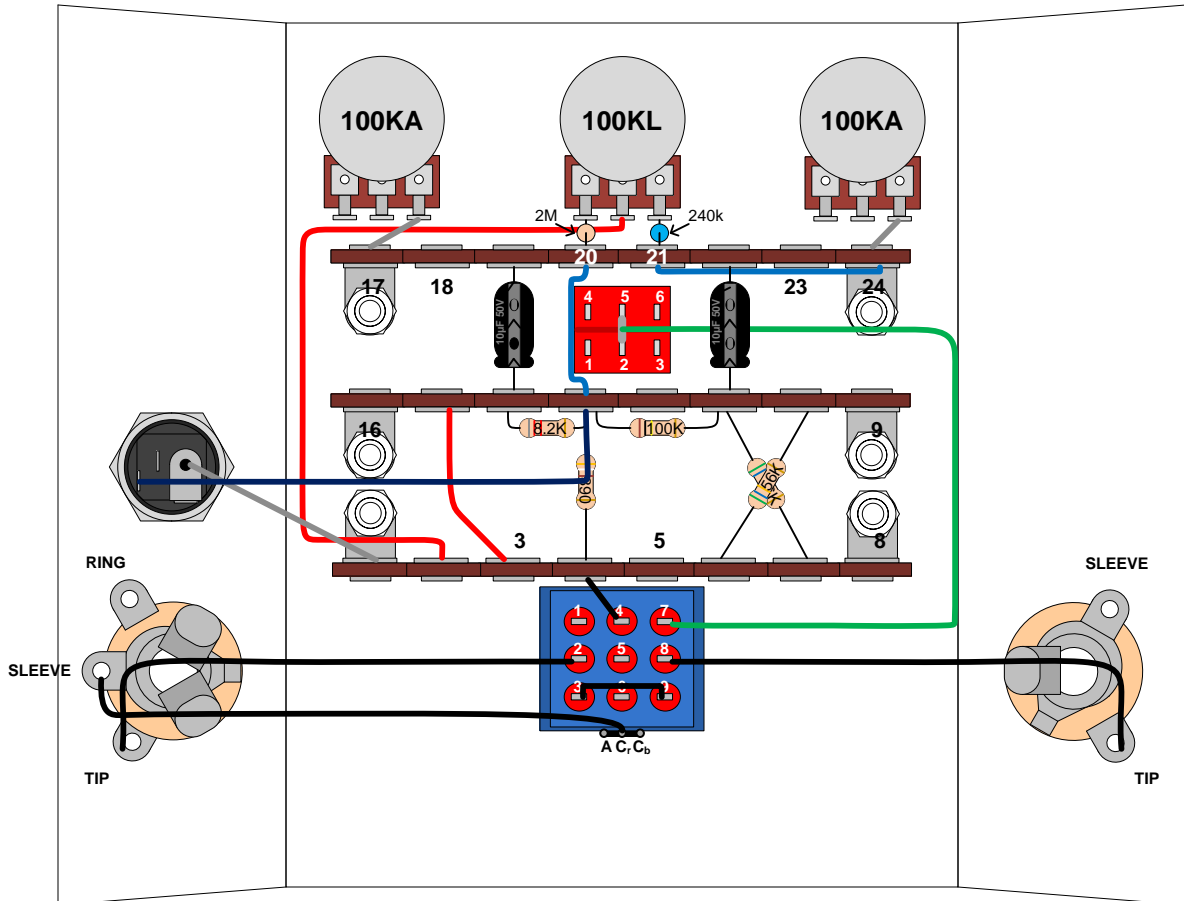

DRAWING 5

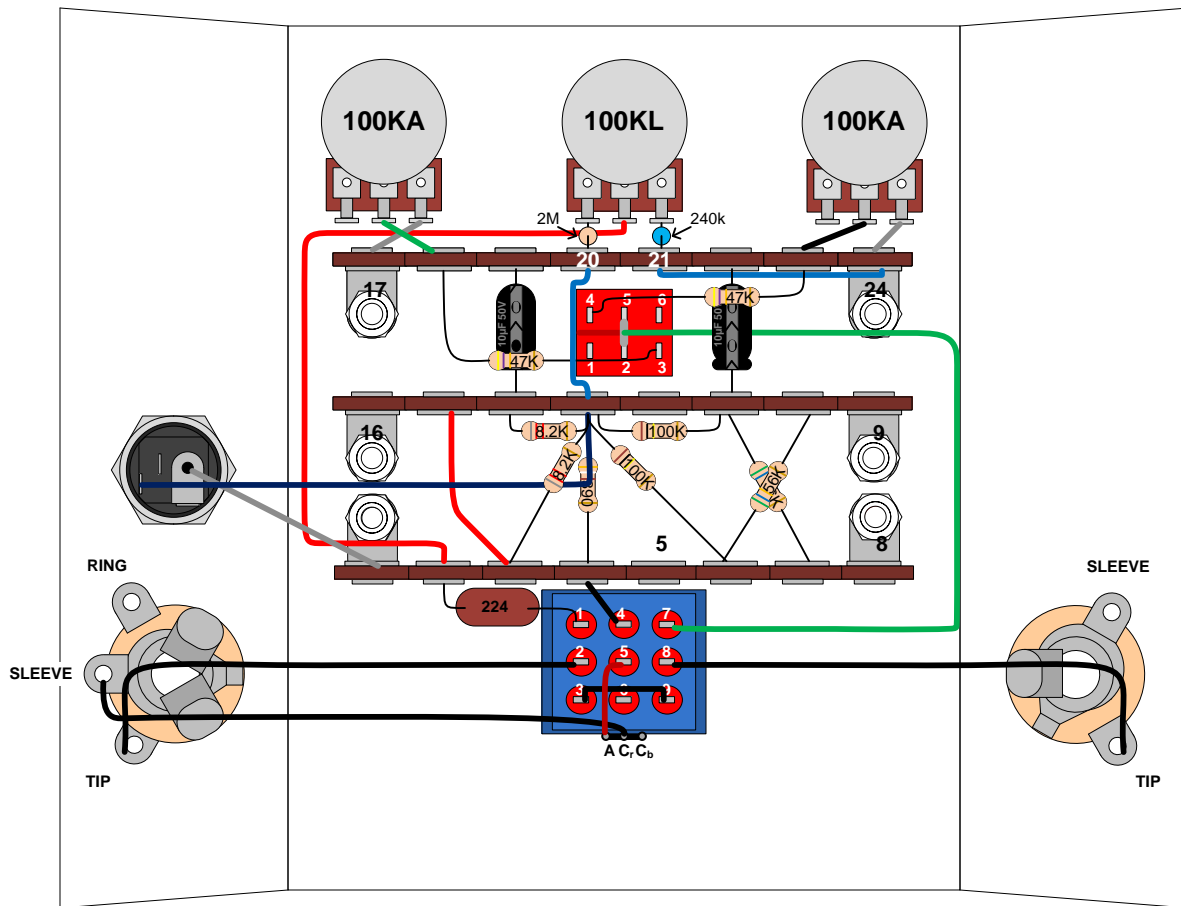

DRAWING 6

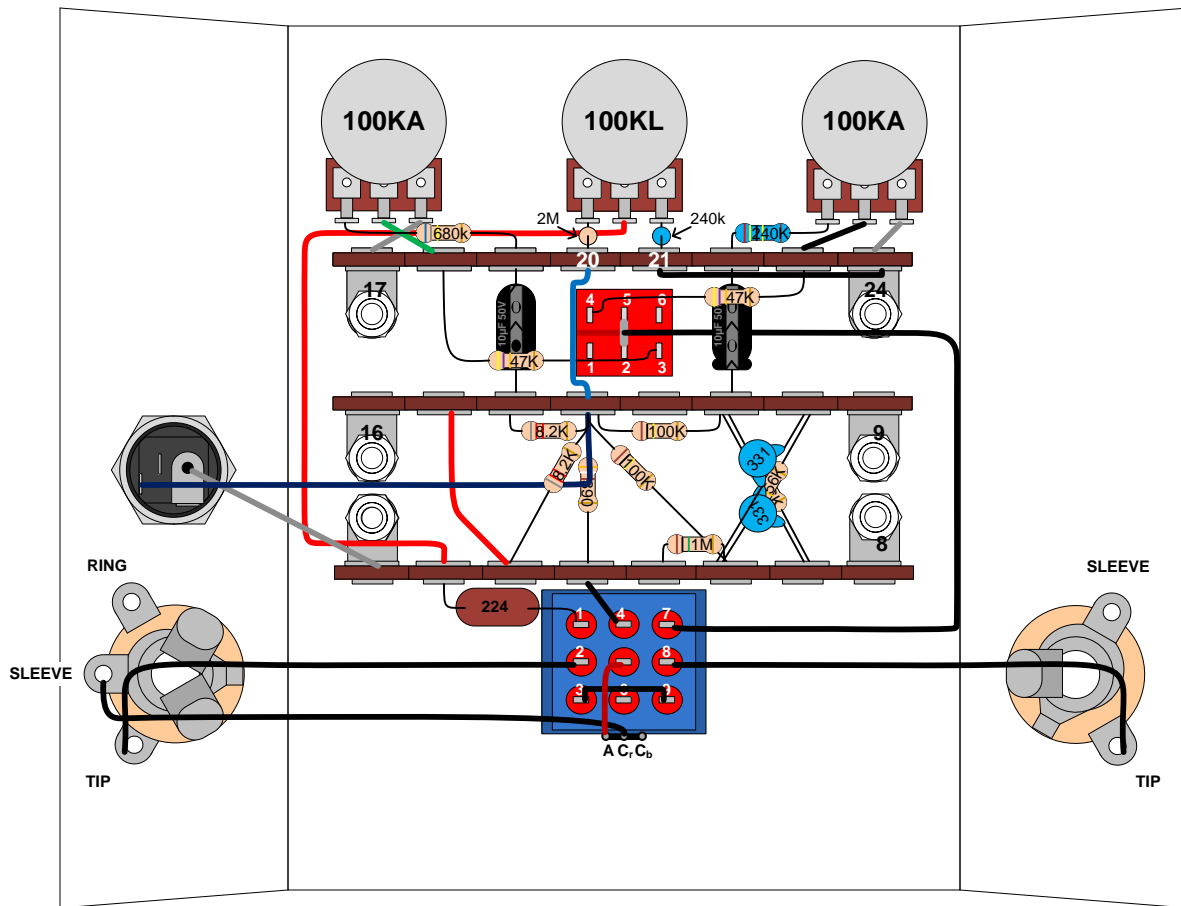

DRAWING 7

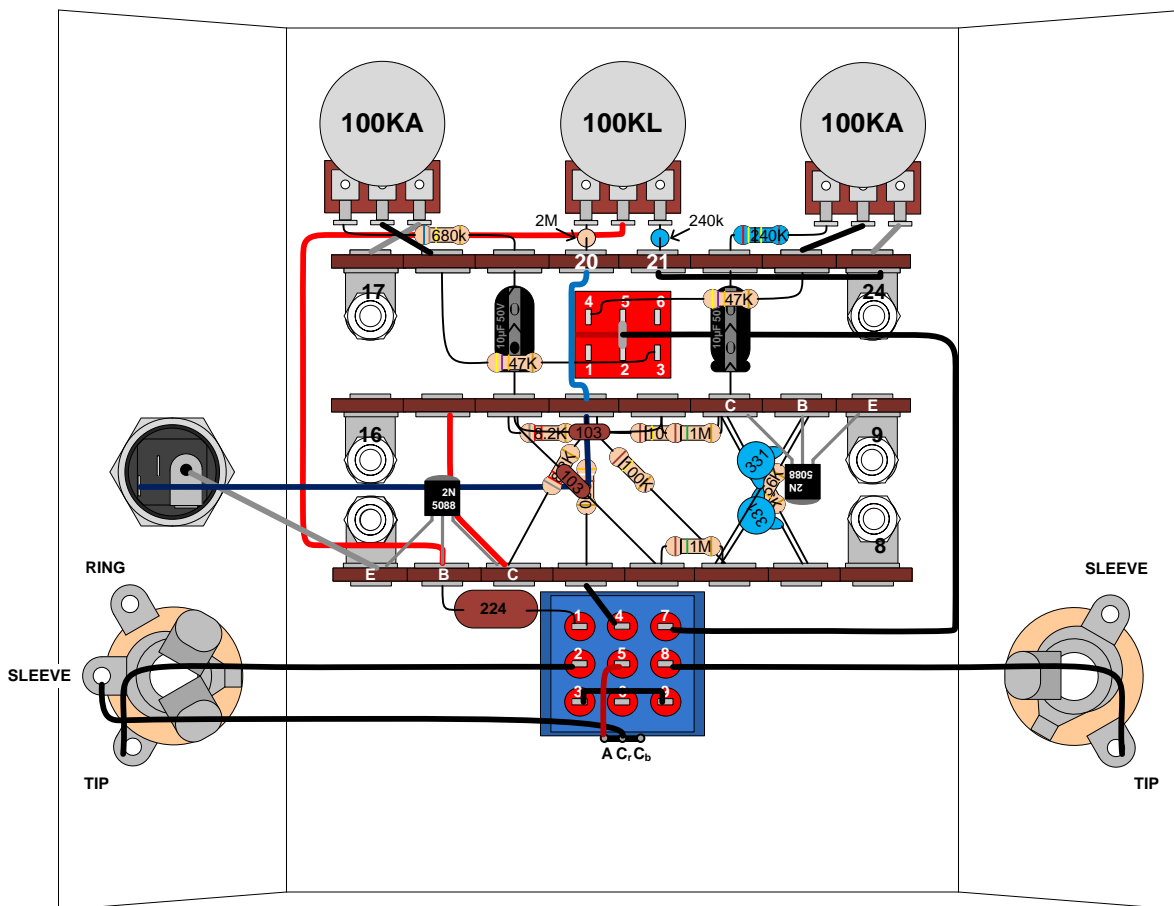

DRAWING 8

