

THE PERSUADER DELUXE (K-980)

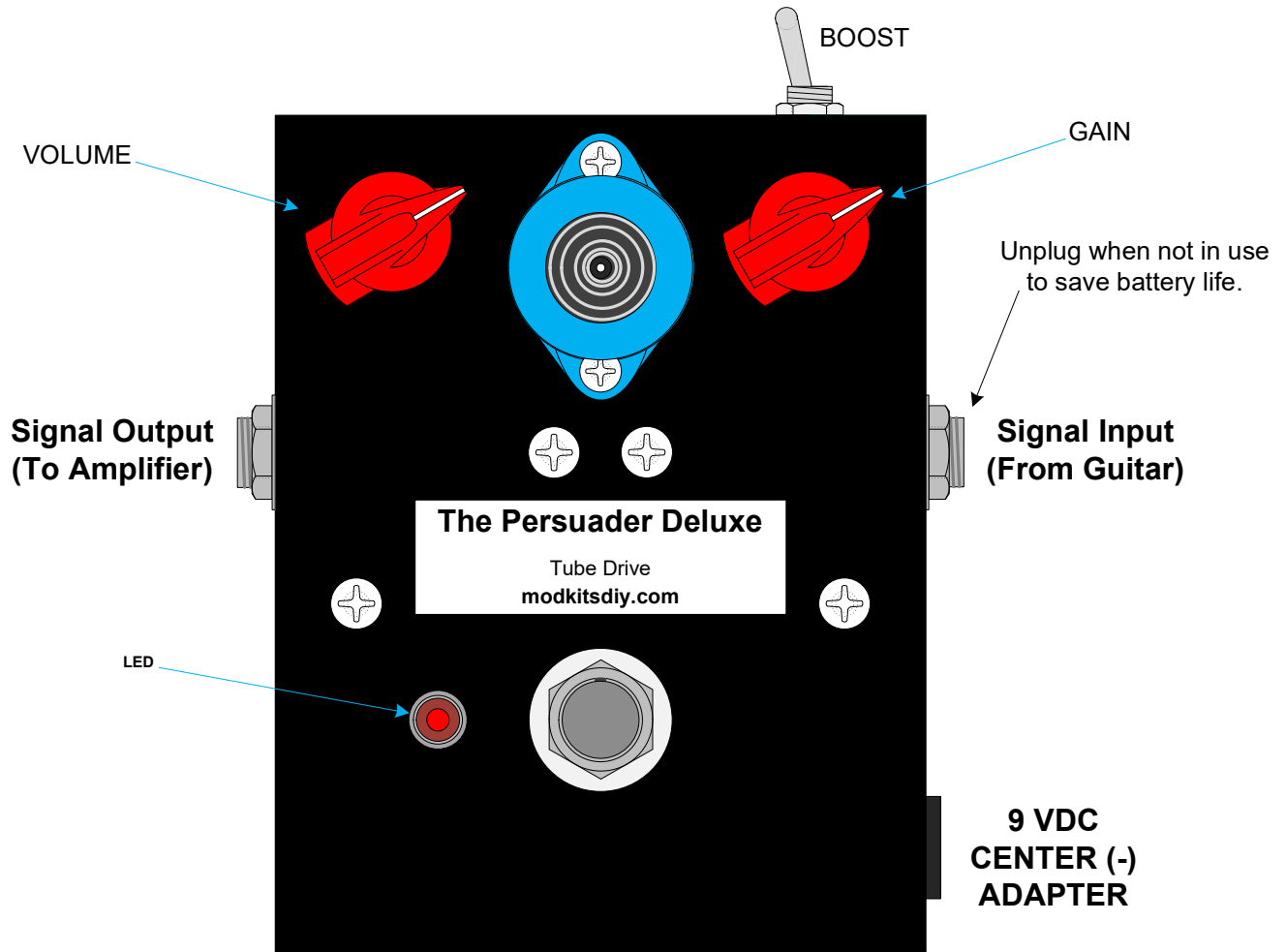

Use these instructions to learn:

- How to build a tube preamp pedal

The Persuader Deluxe utilizes a Darlington preamp to push cascaded triodes into distortion. Four dual triode tubes included with the kit provide a wide range of tones from just a hint of break up from the JJ 5751 to over the top crunchy distortion using the NOS 12AT7. A boost switch provides an additional layer of flexibility with added gain and a little extra bottom end. An LED indicator lights up when the Persuader Deluxe is engaged and not in true bypass mode.

Warning: This circuit was designed for use with a 9 VDC power supply only.

MOD[®]
www.modkitsdiy.com

TABLE OF CONTENTS

TOOL LIST	2
PARTS LIST DRAWINGS.....	3, 4
FINAL ASSEMBLY REFERENCE DRAWING.....	5
SOLDERING TIPS	6
STEP BY STEP ASSEMBLY INSTRUCTIONS	7
Section 1 – Mount ¼” Jacks and Terminal Strip Components.....	7
Section 2 – Mount the Potentiometers, Footswitch, LED and DC Power Jack.....	8
Section 3 – Mount the Tube Socket, Shield and 5 Lug Terminal Strips & Toggle Switch.....	9
Section 4 – Connect the DC Power Components	10
Section 5 – Wiring Connections in the Vacuum Tube Section	10
Section 6 – Mounting Components in the Vacuum Tube Section	11
Section 7 – Wire the Output Jack and Footswitch Connections	12
Section 8 – Finishing Up	12
Suggested Tube Uses	13
<u>ASSEMBLY DRAWINGS</u> (6 Drawings)	13 – 16

These are the last 4 pages. They may be separated and used as a reference to help assemble the kit correctly.

Visit www.modkitsdiy.com if you have any problems when first turning on your pedal for troubleshooting help. Remember to use caution when applying power to the pedal to avoid electric shock.

TOOL LIST

- Wire Strippers
- Needle Nose Pliers
- Cutting Pliers
- Desoldering Pump
- Solder (60/40 rosin core)
- Soldering Station
- Phillips Head Screwdrivers
- Slotted tip screwdrivers (3 mm tip)
- Channellock Pliers (or similar type)
- Ruler
- Hobby Vise (or other means to secure box while working)

PARTS LIST 1

Stranded Wire (22 AWG) - White
K-PUL1569-WHITE (4 FT)

Enclosure
P-H1590BBCE-BK (1)

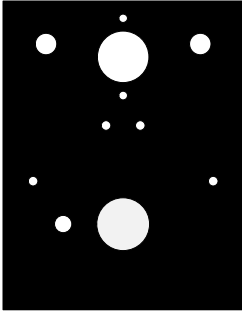

Mini Chicken Head Knob
P-K900R (2)

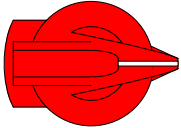

Battery Clip
S-H155 (1)

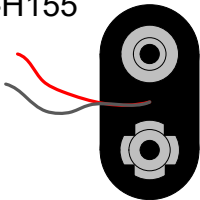

1/4" Mono Jack (Output Jack)
W-SC-11-T (1)

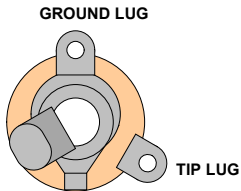

1/4" Stereo Jack (Input Jack)
W-SC-12B (1)

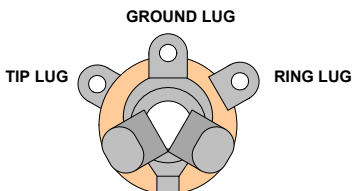

3PDT Foot Switch
P-H501 (1)

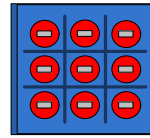

Preamp Tubes (Dual Triode)
T-12AT7_ECC81 (1)
T-12AU7-JJ (1)
T-12AX7B-CHINA (1)
T-5751-JJ (1)

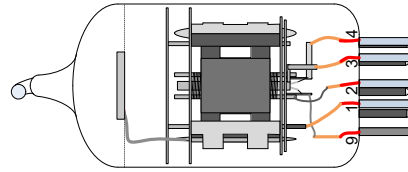
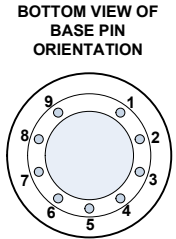

Potentiometers: 250KA and 1KL
R-VA250KA (1)
R-VA1KL (1)

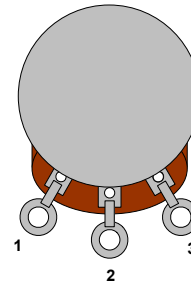

Terminal Strips with 5 Terminals

P-0501H01 (1)
1st Lug Common

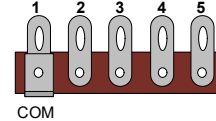

P-0501H05 (1)
5th Lug Common

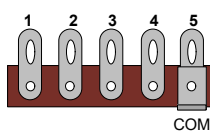

Terminal Strip with 8 Terminals

P-0802H (1)

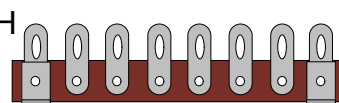

#6 Screws (3/8" long)

S-HS632-38 (4)



#6 Lock Washers (3/8" long)

S-HLW6 (4)



#6 Nuts

S-HHN632 (4)



PARTS LIST 2

#4 Screws (3/8" long)

S-HS440-12  (2)

#4 Nuts

S-HHN440  (2)

#4 Lock Washers

S-HLW4  (2)

DC Power Jack

S-H750  (1)

NPN Darlington (MPSA13)

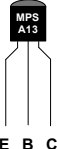
P-QMPSA13  (1)

220 μ F Polarized Capacitor 50V

C-ET220-50  (1)

25 μ F Polarized Capacitor 25V

C-ET25-25  (1)

0.1 μ F Capacitor 100V

C-PEID1-100  (4)

Tube Socket and Shield

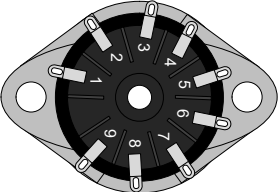
P-ST9-300  (1)

Light Emitting Diode

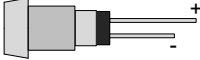
P-L400  (1)

220 Ω Resistor 1/2 W

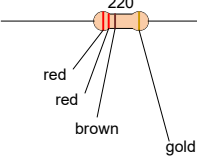
R-A220  (2)

4.7k Ω Resistor 1/2 W

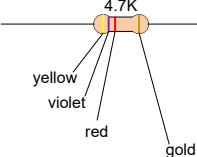
R-A4D7K  (1)

110k Ω Resistor 1/2 W

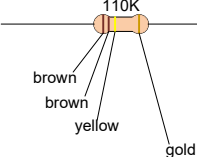
R-A110K  (1)

150k Ω Resistor 1/2 W

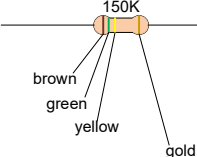
R-A150K  (1)

200k Ω Resistor 1/2 W

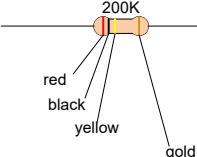
R-A200K  (1)

Toggle Switch, Mini (SPDT)

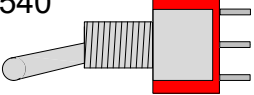
P-H540  (1)

220k Ω Resistor 1/2 W

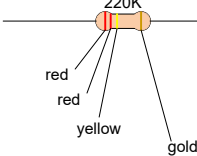
R-A220K  (2)

680k Ω Resistor 1/2 W

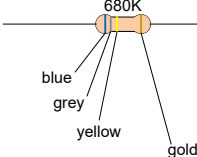
R-A680K  (1)

1M Ω Resistor 1/2 W

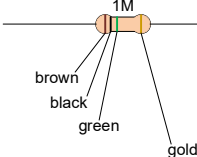
R-A1M  (1)

2M Ω Resistor 1/2 W

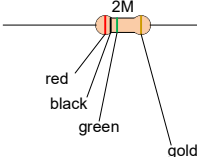
R-A2M  (1)

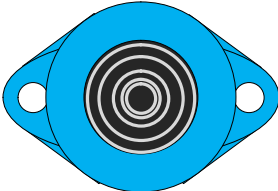
P-SS9-325-BL  (1)

FINAL ASSEMBLY REFERENCE DRAWING

This is a large version of the final assembly drawing. Refer to this drawing as you make your way through each step of the instructions. Before you make a new connection at a particular terminal or solder lug, notice how many other connections will be made at that terminal. That way you can decide whether it's best for you to solder the connection and leave space open for future connections or hold off on soldering until after every connection at that location has been made.

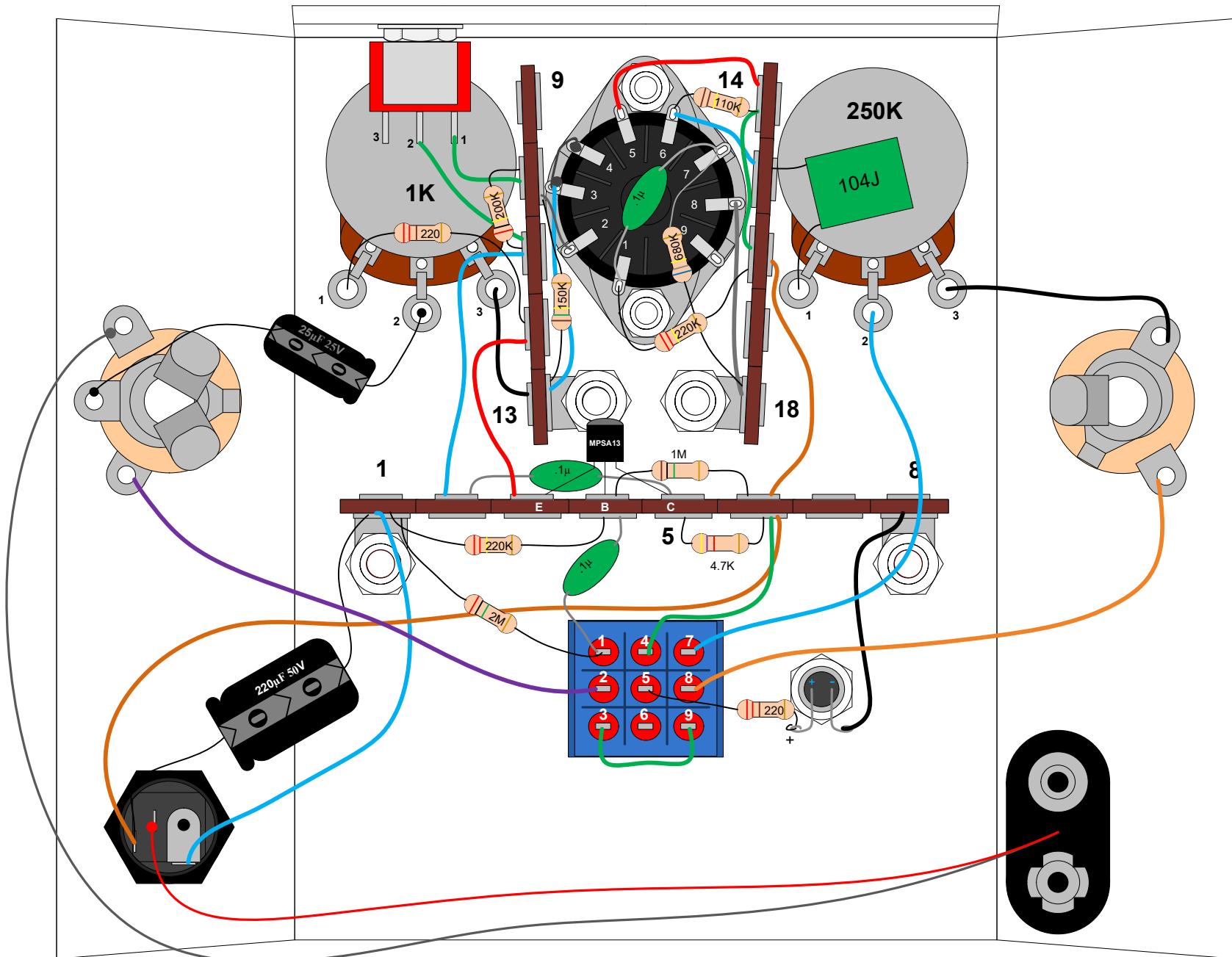

SOLDERING TIPS

It is important to make a good solder joint at each connection point. A cold solder joint is a connection that may look connected but is actually disconnected or intermittently connected. (A cold solder joint can keep your project from working.)

Follow these tips to make a good solder joint. *Take your time with each connection and make sure that all components are connected and will remain connected if your project is bumped or shaken.*

1. Bend the component lead or wire ending and wrap it around the connection point.
 - Make sure it is not too close to a neighboring component which could cause an unintended connection.
2. Wrap the component lead so that it can hold itself to the connection point.
3. Touch the soldering iron to both the component lead and the connection point allowing both to warm up just before applying the solder to them.
4. Be sure to adequately cover both component lead and connection point with melted solder.
 - Remove the soldering iron from your work and allow the solder joint to cool. (The solder joint should be shiny and smooth after solidifying.)
 - Cut off any excess wire or component leads with cutting pliers.
 - Clean the soldering iron's tip by wiping it across the wet sponge again after making the solder joint.

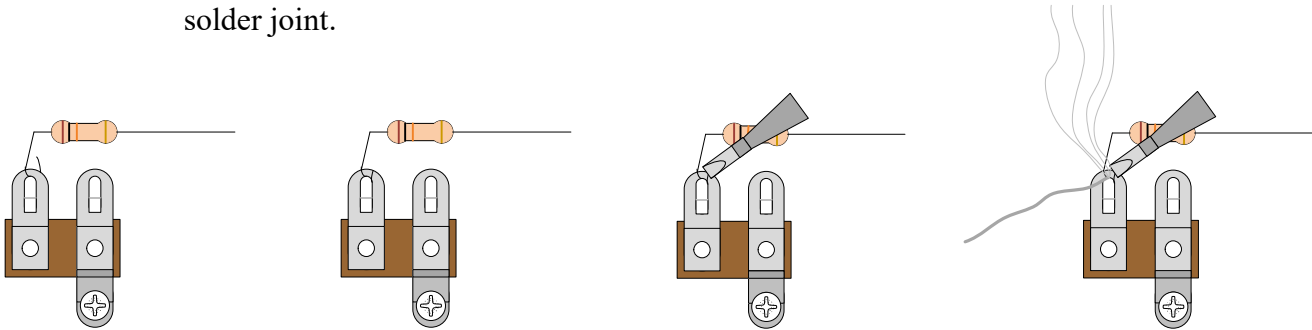

1. Bend the component lead and wrap it around the connection point.

2. Wrap the component lead so that it can hold itself to the connection point.

3. Heat up both component lead and connection point with the soldering iron.

4. Apply solder to both component lead and connection point.

De-Soldering Tip

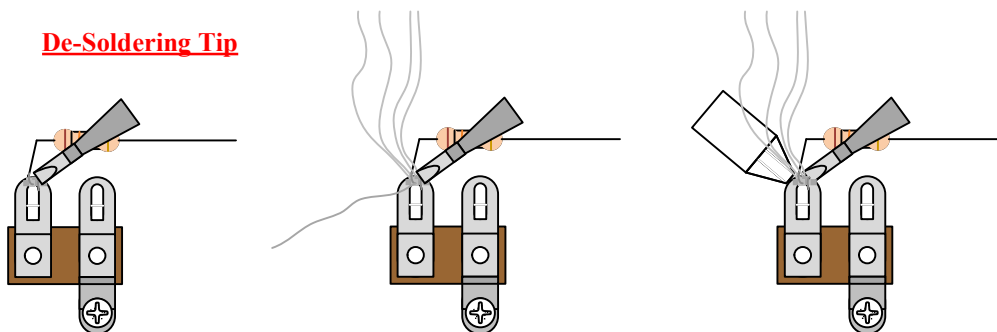

1. Heat up old solder joint with the soldering iron.

2. Apply fresh solder to mix in with old solder joint

3. Use a de-soldering tool to remove the old solder joint while it is heated.

SECTION 1 – Mount 1/4" Jacks and Terminal Strip Components

Please refer to **DRAWING 1** and **DRAWING 2**.

Orient box with two 5/16" holes on top and 1/2" hole nearest you.

Mount input jack in 3/8" hole on left side of box with hardware provided. Washer goes under nut on outside of box. Make sure center solder lug of input jack is facing up. Correct positioning of jack will make soldering connections much easier. When positioned correctly, tighten nut.

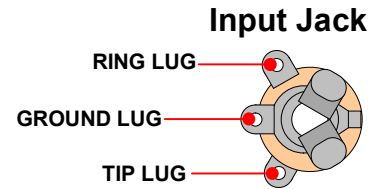

Mount output jack in 3/8" hole on right side of box with hardware provided. Washer goes under nut on outside of box. Make sure two solder lugs are in most upright position before tightening nut.

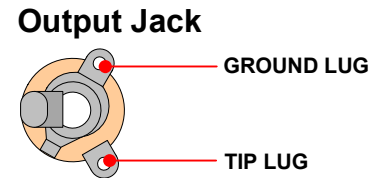

Mount the 8 lug terminal strip to the two 9/64" holes as shown in drawing 2 using #6 hardware. We will refer to terminal numbers as illustrated below when connecting components.

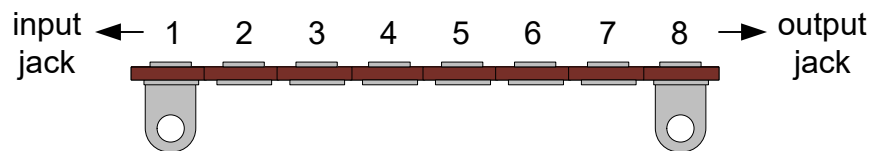

Stripping and tinning wire: Throughout these instructions you will be told to strip and tin a length of wire numerous times. Unless noted otherwise, cut the wire to the length stated in the instructions, then strip 1/4" of insulation off each end. Twist each end of the stranded wire and apply a small amount of solder to each end (tin the wire ends). This prevents the stranded wire from fraying and makes soldering much easier.

Connect and solder all of the following to their respective terminals as listed. (Make sure none of the component leads are so close together that it could lead to an unintended connection). *Be careful not to overheat the MPSA13 transistor when soldering.*

Terminals #4 and #6 will have more than 3 components/leads connected to them. Because of this we will use both the upper and lower portion of the terminal.

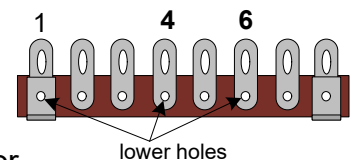

1) Mount the components and leads to the *lower set of holes*, but do not solder.

Terminals #1 & 4:

- 220K resistor

Terminals #4 & 6:

- 1M resistor

Terminals #5 & 6:

- 4.7K resistor

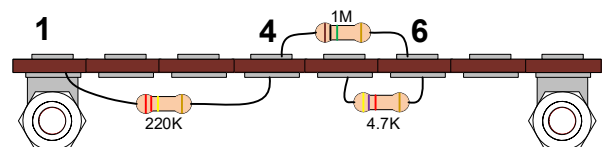

Solder the lower terminal hole connections on **Terminals #1, 4, 5 and 6** now.

The remaining components and wires can be connected to the upper portion of their respective terminals. Unless otherwise noted, "mount" means to mount the component, solder the component in place and trim the leads.

2) Mount two of the .1 μ F capacitors.

Terminals #2 & 5:

Mount one .1 μ F cap to terminals #2 and #5 with the cap upside down and its leads facing up. This will allow room for the next component to be mounted in the same area.

(Make sure the leads of the cap do not come into contact with any terminals besides terminals #2 and #5).

Terminal #4:

Turn another .1 μ F cap upside down with the leads facing up and mount one lead to terminal #4. (The other lead will be connected to the footswitch later in these instructions).

3) Mount the MPSA13 transistor.

Be careful not to overheat the MPSA13 transistor when soldering.

Terminals #3, 4 & 5:

- "Emitter" to terminal #3
- "Base" to terminal #4
- "Collector" to terminal #5

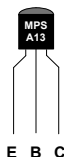

SECTION 2 – Mount the Potentiometers, Footswitch, LED and DC Power Jack

Please refer to DRAWING 3.

Mount the 1K potentiometer in the upper left hole using hardware provided. Mount the 250K potentiometer in the upper right hole using the hardware provided. Solder lugs for both pots should be pointed toward the bottom side of the enclosure. *(Remove the small mounting tab on each pot by bending it back with pliers).*

Mount footswitch in the 1/2" hole. The large nylon washer goes under the mounting nut on the outside of the box. The Lock washer mounts on the inside of the box between the box surface and the other nut. Make sure that the footswitch solder lugs are oriented left to right, not up and down as illustrated here.

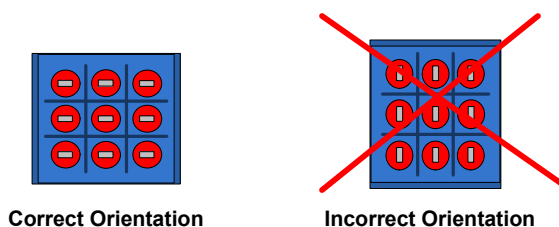

Mount the power adapter jack in the 15/32" hole on the bottom left side of box. Orient the solder lugs on the power adapter jack so the larger center-pin lug is facing the bottom side of the box. Tighten the adapter jack.

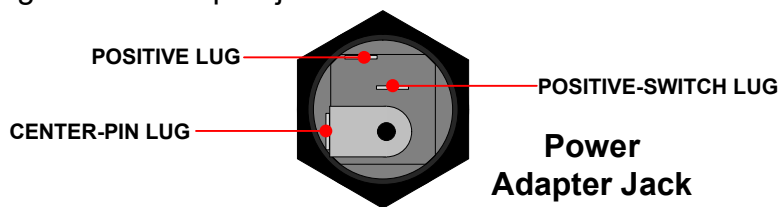

Mount the LED in the 1/4" hole next to the footswitch. Align the LED leads so that the anode (long lead) is closer to the footswitch.

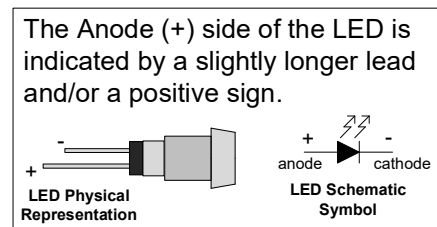

SECTION 3 – Mount the Tube Socket, Shield, 5 Lug Terminal Strips & Toggle Switch

Please refer to DRAWING 3.

Use the #4 screws, lock washers and nuts to mount the tube socket and shield as shown below.

- 1) From outside of the enclosure, insert the two #4 screws through the mounting holes of the tube shield base and into the two 1/8" chassis holes.
- 2) Place the tube socket onto the two screws so that the gap between pins 1 and 9 is directed toward the end of the box with the footswitch.

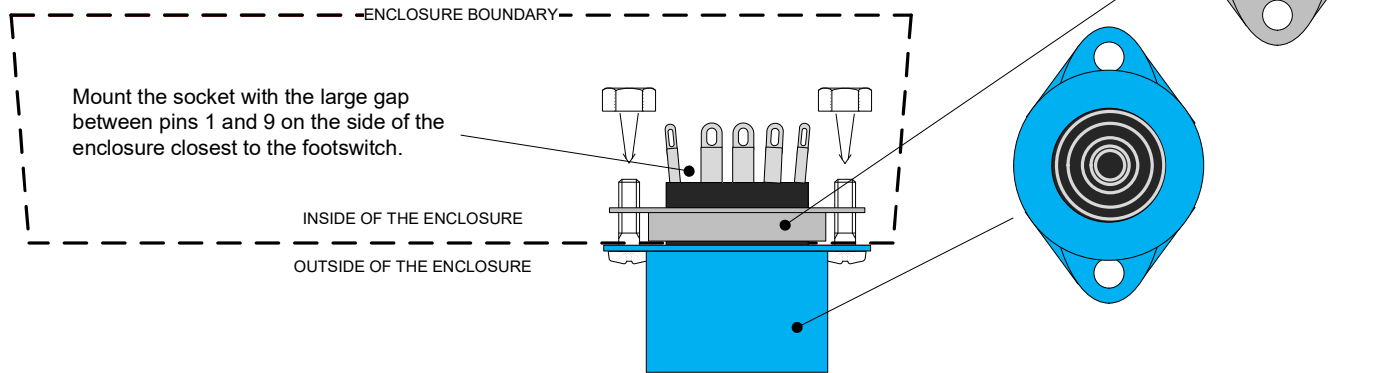

Note: Due to variance in socket manufacturing, the pins on your socket may not be in the same position relative to the socket's mounting holes as shown in the layout drawings; however, the gap in the socket will always be between pins 1 and 9. Make sure you are making your tube socket connections to the correct pin numbers with respect to the gap and not their position relative to the mounting holes.

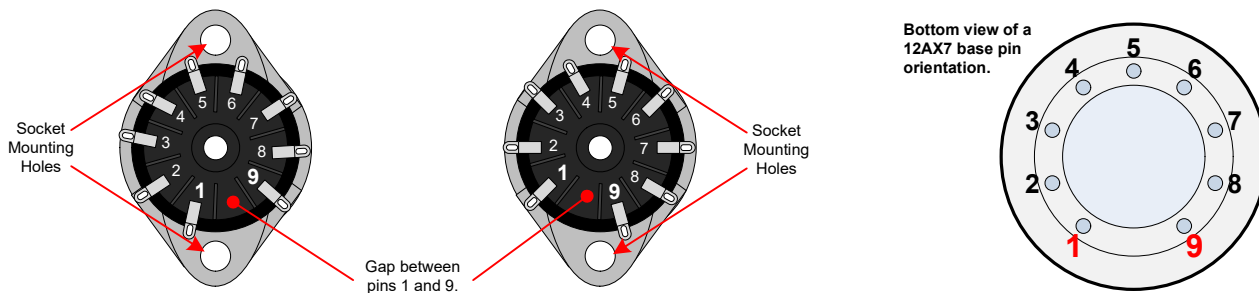

- 3) Fasten the two #4 lock washers and nuts onto the two screws and tighten.

(Because the space is tight and the nuts/washers are small, it may be helpful to insert the screws and place a piece of masking tape over them to hold them in place to make it easier to get the washer and nut on the screw after the socket is in place.)

- 4) Mount the 5 lug terminal strip with the grounded terminal #1 between the 1K pot and the tube socket using #6 hardware.

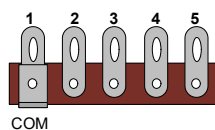

Be careful to mount these so that none of the terminals are unintentionally shorted to ground by surface to surface contact with the tube socket or potentiometer bodies.

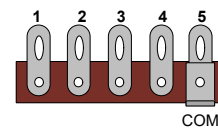

- 5) Mount the 5 lug terminal strip with the grounded terminal #5 between the 250K pot and the tube socket using #6 hardware.

- 6) Mount the toggle switch in the 1/4" hole adjacent to the 1K gain pot using hardware provided.

SECTION 4 – Connect the DC Power Components

Please refer to **DRAWING 3**.

Locate the battery snap connector. Connect and solder the red lead to the positive-switch lug of the power adapter jack.

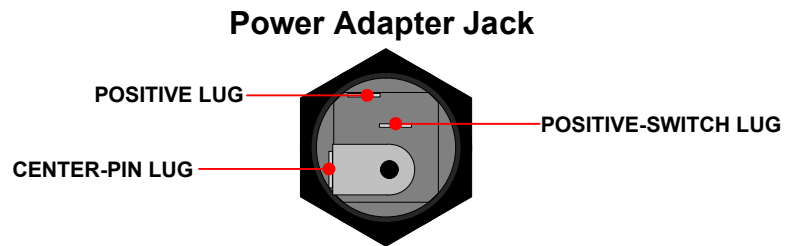

Connect and solder the black lead to ring lug on the input jack.

Connect the positive lead of the remaining 220 μ F capacitor to the positive lug on the adapter jack (do not solder here, yet). Connect the negative lead of this cap to terminal #1.

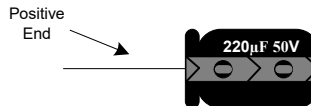
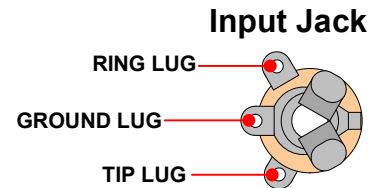

Stripping and tinning wire: Throughout these instructions you will be told to strip and tin a length of wire numerous times. Unless noted otherwise, cut the wire to the length stated in the instructions, then strip $\frac{1}{4}$ " of insulation off each end. Twist each end of the stranded wire and apply a small amount of solder to each end (tin the wire ends). This prevents the stranded wire from fraying and makes soldering much easier.

Strip and tin a 4 $\frac{1}{2}$ " length of wire. Wrap one end around the positive lug of the adapter jack (same terminal as the 220 μ F capacitor). Now solder this connection and make sure the positive capacitor lead and wire end are not touching the nearby adapter jack lugs. Connect the other end of this wire to terminal #6.

Strip and tin a 2 $\frac{1}{2}$ " length of wire and connect the adapter jack center-pin lug to terminal #1.

SECTION 5 – Wiring Connections in the Vacuum Tube Section

Please refer to **DRAWING 4**.

1) Strip and tin a 2 $\frac{1}{2}$ " piece of wire and connect:

Terminals #6 & #16

2) Strip and tin a 1 $\frac{1}{2}$ " piece of wire and connect:

Terminals #14 & #16

Routing this wire along the bottom of the terminal strip on the side next to the tube socket can make for a nice insulator to ensure that terminals #15 and #16 will not short out against the tube socket.

3) Cut a 1" piece of wire and connect:

Tube Pin 5 to Terminal #14

4) Cut a 3 $\frac{1}{4}$ " piece of wire. Strip $\frac{3}{8}$ " of insulation from one end and $\frac{1}{4}$ " of insulation from the other end. Connect:

Tube Pins 3 & 4 to Terminal #13

Connect the longer end to tube socket pins 3 & 4. Connect the other end to terminal #13.

5) Strip $\frac{3}{4}$ " of insulation from the end of the wire supply and tin. Snip off the $\frac{3}{4}$ " piece of tinned wire and connect:

Tube Pin 2 to Terminal #10

6) Strip and tin a 1" piece of wire and connect:

Toggle switch lug 1 to Terminal #10

7) Strip and tin a 1 ½" piece of wire and connect:

Toggle switch lug 2 to Terminal #11

8) Strip and tin a 1 ½" piece of wire and connect:

1KL pot lug 3 to Terminal #13

9) Strip and tin a 2 ½" piece of wire and connect:

Terminals #2 & #11

10) Strip and tin a 1 ¾" piece of wire and connect:

Terminals #3 & #12

11) Strip and tin a 2" piece of wire and connect:

Tube Pin 8 & Terminal #18

12) Strip ¾" of insulation from the end of the wire supply and tin. Snip off the ¾" piece of tinned wire and connect:

Tube Pin 6 & Terminal #15 *-Don't solder at Pin 6, yet.*

SECTION 6 – Mounting Components in the Vacuum Tube Section

Please refer to DRAWING 5.

1) Mount the 25µF cap to the input jack's ground lug and 1KL pot lug 2. Make sure the negative (-) end of the cap is connected to ground.

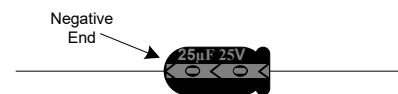

2) Connect the 220 Ω resistor to:

1KL Pot lug 1 & Terminal #12

3) Connect the 150K resistor to:

Terminals #10 & #13

4) Connect the 200K resistor to:

Terminals #10 & #11

5) Connect the 110K resistor to:

Tube pin 6 & Terminal #14 *-You can solder the Pin 6 connection, now.*

6) Connect the 680K resistor to:

Tube pin 7 & Terminal #18 *-Don't solder at Pin 7, yet.*

7) Connect the 220K resistor to:

Tube pin 1 & Terminal #16 *-Don't solder at Pin 1, yet.*

8) Connect a .1µF cap to:

Tube pins 1 & 7 *-You can solder the Pins 1 & 7 connections, now.*

9) Connect the remaining .1 μ F cap to:

250KA Pot lug 1 & Terminal #15

SECTION 7 – Wire the Output Jack and Footswitch Connections

Please refer to **DRAWING 6**.

Footswitch lug numbering convention

1) Locate the unattached end of the .1 μ F cap (from Section 1) and connect to:

Footswitch lug 1 *-Don't solder the footswitch connection, yet.*

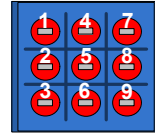

2) Connect the 2M resistor to:

Footswitch lug 1 & Terminal #1 *-You can solder the lug 1 connection, now.*

3) Connect the remaining 220 Ω resistor to:

Footswitch lug 5 & LED Anode (+) ←

(Make sure the resistor lead does not short against any of the other Footswitch lugs).

Clip the anode lead of the LED and resistor to a reasonable length and connect them by bending and crimping the leads around each other. Solder them once they are tightly connected to each other.

4) Strip and tin a 1 ½" piece of wire and connect:

LED Cathode (-) & Terminal #8

5) Strip and tin a 2" piece of wire and connect:

Footswitch lug #4 & Terminal #6

6) Strip and tin a 1 ½" piece of wire and connect:

Footswitch lugs 3 & 9

7) Strip and tin a 4" piece of wire and connect:

250KA Pot lug 2 & Footswitch lug 7

8) Strip and tin a 1 ½" piece of wire and connect:

Output Jack's ground lug & 250KA Pot lug 3

9) Strip and tin a 2 ½" piece of wire and connect:

Output Jack's tip lug & Footswitch lug 8

10) Strip and tin a 3" piece of wire and connect:

Input Jack's tip lug & Footswitch lug 2

Output Jack

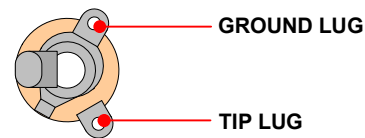

Input Jack

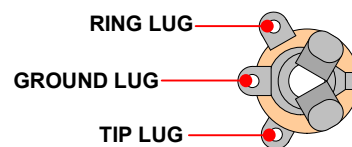

SECTION 8 – Finishing Up

It's always a good idea to thoroughly double-check your connections before applying power.

Attach the knobs provided to the two potentiometer shafts. Install 9 volt battery, close cover using screws provided. Plug guitar into input jack on right. This turns unit on. Plug cable into output jack and plug into your amplifier. Battery will last only about 1 hour of continuous operation. 9 volt, center negative power supply is highly recommended for use with this unit.

Unplug from the input jack of the unit to turn it off and save power.

Suggested Tube Uses

JJ 5751: Subtle bluesy style break up at low gain settings capable of being overdriven to distortion at highest gain settings, with overall lower volume. At lowest gain settings it provides approximately unity gain at full volume.

12AX7B-China: With a gain factor of two, at minimum gain settings this tube provides a clean boost and falls into the overdrive category at maximum gain settings.

JJ ECC82: JJ's version of the 12AU7 displays light distortion at minimum gain settings and covers the same territory as the 12AX7B-China at middle gain settings. With the boost switch engaged it goes beyond overdrive into fuzz/distortion, with a gain factor of four.

NOS 12AT7: Often relegated to the role of phase inverter or reverb driver, the 12AT7 really shines in the Persuader Deluxe. At minimum gain settings, it will provide a clean boost just this side of overdrive, and with a gain factor of 6, launches into aggressive distortion at maximum gain.

DRAWING 1

