

# THE PENETRATOR (K-996)

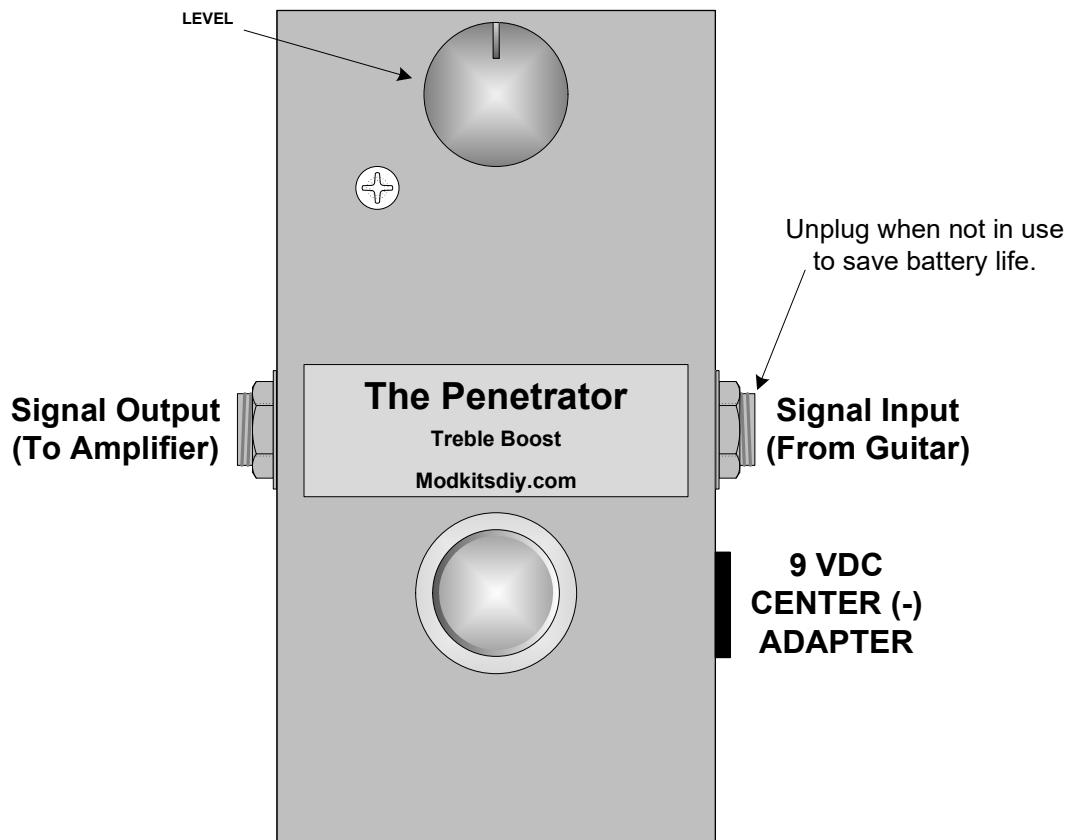

## Use these instructions to learn:

- How to build an effects pedal for treble boost.

The Penetrator is a treble boost pedal kit with enough to gain to cut straight through a mix. Adjust the level knob to vary the output so there's no mistaking when you kick this pedal in. Great for solos or when you need your guitar front and center, this pedal adds glistening harmonics to your sound.

**Warning:** *This circuit was designed for use with a 9 VDC power supply only.*

**MOD**<sup>®</sup>  
www.modkitsdiy.com

## **TABLE OF CONTENTS**

TOOL LIST .....	2
PARTS LIST DRAWINGS.....	3, 4
SOLDERING TIPS .....	5
STEP BY STEP ASSEMBLY INSTRUCTIONS .....	6
Section 1 – Mount Hardware and Wire Power .....	6
Section 2 – Mount Wires and Selected Components .....	6
Section 3 – Mount and Connect Remaining Components .....	7
Section 4 – Finishing Up .....	7

<b><u>ASSEMBLY DRAWINGS</u></b> (4 Drawings) .....	8, 9
These are the last 2 pages. They should be separated and used as a reference to help assemble the kit correctly.	

---

### **TOOL LIST**

- Wire Strippers
- Needle Nose Pliers
- Cutting Pliers
- Desoldering Pump
- Solder (60/40 rosin core)
- Soldering Station
- Phillips Head Screwdrivers
- Hex Keys (Allen Wrenches)
- Slotted tip screwdrivers (3 mm tip)
- Channellock Pliers (or similar type)
- Ruler
- Hobby Vise (or other means to secure box while working)

# PARTS LIST 1

Stranded Wire (22 AWG) - Black  
K-PUL1569-BLACK (2.25 FT)

Spaghetti - Old-Style, White, 20 AWG  
S-M436W (1.5 IN)

Enclosure  
P-H1590BCE (1)

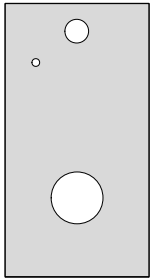

Knob (Aluminum)  
P-K310 (1)

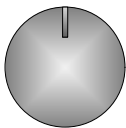

Battery Clip  
S-H155 (1)

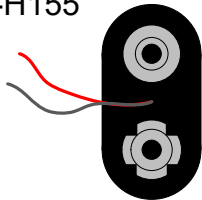

1/4" Mono Jack (Output Jack)  
W-SC-11-T (1)

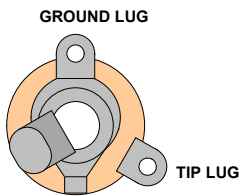

1/4" Stereo Jack (Input Jack)  
W-SC-12B (1)

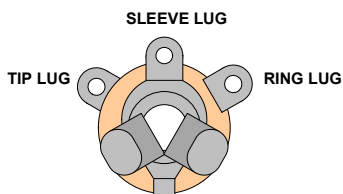

DC Power Jack  
S-H750 (1)



3PDT LED Foot Switch  
P-H590-RB (1)

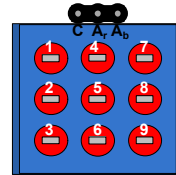

Potentiometers: 100KA  
R-VAM100KA-SS (1)

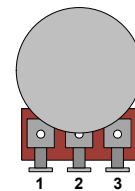

Terminal Strip with 2 Terminals  
P-0201H (1)

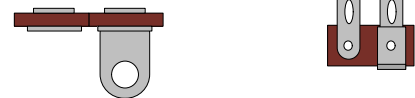

Terminal Strip with 5 Terminals  
P-0501H01 (1)

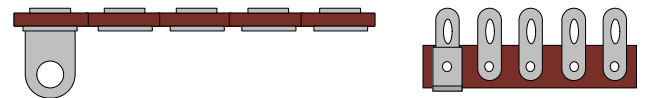

#4 Screw (3/8" long)  
S-HS440-38 (1)



#4 Nut  
S-HHN440 (1)



#4 Lock Washer  
S-HLW4 (1)



## PARTS LIST 2

NPN BJT (2N5088)

P-Q2N5088 (1)

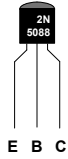

47 $\mu$ F Polarized Capacitor 50V

C-ET47-50 (1)



0.047 $\mu$ F Capacitor

C-PEID047-100 (1)



0.0047 $\mu$ F Capacitor

C-PEID0047-100 (1)

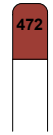

1K $\Omega$  Resistor  $\frac{1}{2}$  W

R-A1K (1)

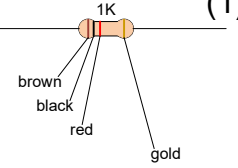

1.2k $\Omega$  Resistor  $\frac{1}{2}$  W

R-A1D2K (1)

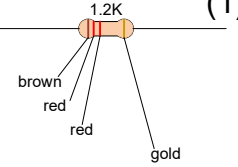

2.2k $\Omega$  Resistor  $\frac{1}{2}$  W

R-A2D2K (1)

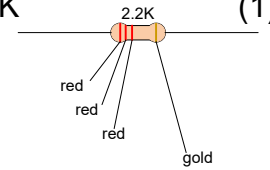

8.2k $\Omega$  Resistor  $\frac{1}{2}$  W

R-A8D2K (1)

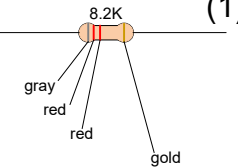

22k $\Omega$  Resistor  $\frac{1}{2}$  W

R-A22K (1)

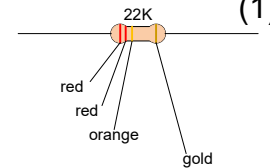

100k $\Omega$  Resistor  $\frac{1}{2}$  W

R-A100K (1)

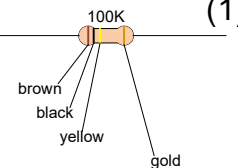

220k $\Omega$  Resistor  $\frac{1}{2}$  W

R-A220K (1)

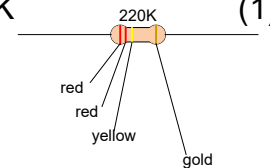

## SOLDERING TIPS

It is important to make a good solder joint at each connection point. A cold solder joint is a connection that may look connected but is actually disconnected or intermittently connected. (A cold solder joint can keep your project from working.)

Follow these tips to make a good solder joint. *Take your time with each connection and make sure that all components are connected and will remain connected if your project is bumped or shaken.*

1. Bend the component lead or wire ending and wrap it around the connection point.
  - Make sure it is not too close to a neighboring component which could cause an unintended connection.
2. Wrap the component lead so that it can hold itself to the connection point.
3. Touch the soldering iron to both the component lead and the connection point allowing both to warm up just before applying the solder to them.
4. Be sure to adequately cover both component lead and connection point with melted solder.
  - Remove the soldering iron from your work and allow the solder joint to cool. (The solder joint should be shiny and smooth after solidifying.)
  - Cut off any excess wire or component leads with cutting pliers.
  - Clean the soldering iron's tip by wiping it across the wet sponge again after making the solder joint.

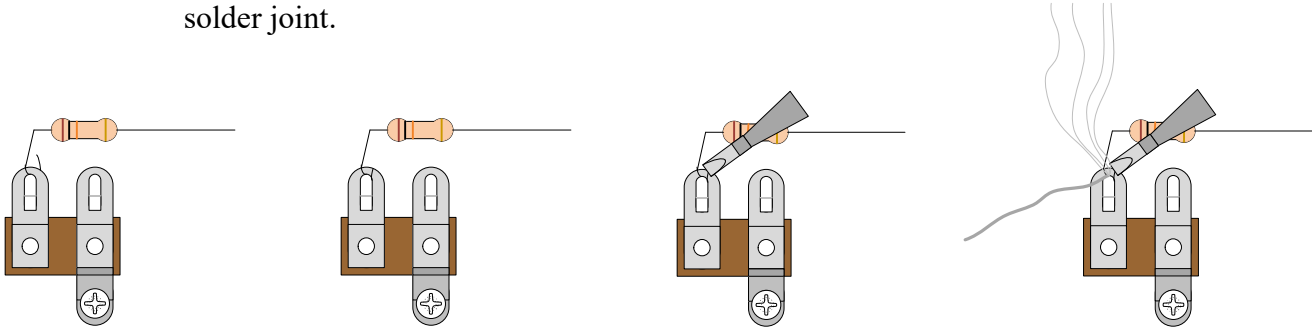

1. Bend the component lead and wrap it around the connection point.

2. Wrap the component lead so that it can hold itself to the connection point.

3. Heat up both component lead and connection point with the soldering iron.

4. Apply solder to both component lead and connection point.

### De-Soldering Tip

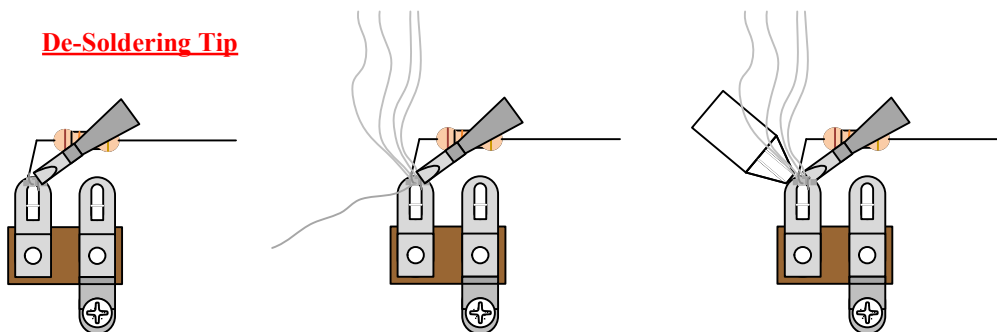

1. Heat up old solder joint with the soldering iron.

2. Apply fresh solder to mix in with old solder joint

3. Use a de-soldering tool to remove the old solder joint while it is heated.

## SECTION 1 – Mount Hardware and Wire Power

Please refer to **DRAWING 1** and **DRAWING 2**.

*Orient the box with 3/4" hole nearest you facing down.*

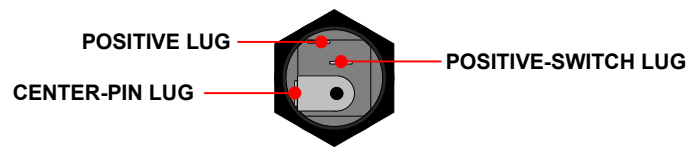

- Mount the DC power jack in the 15/32" hole on the left side of the enclosure. Orient its solder lugs so that the center-pin lug is facing the bottom side of the enclosure.

- Mount the 5 lug and 2 lug terminal strips to the 1/8" hole as shown in drawing 2 using the #4 screw nut and lock washer. The lock washer goes under the nut inside the chassis.

Be sure that no lugs are touching the sides of the box. We will refer to terminal numbers 1 through 7 as #1, #2, etc.

- Mount input jack in 3/8" hole on left side of box with hardware provided.

Washer goes under nut on outside of box. Make sure to orient the jack as shown in Drawing 2. When positioned correctly, tighten nut.

- Mount output jack in 3/8" hole on right side of box with hardware provided.

Washer goes under nut on outside of box. Make sure to orient the jack as shown in Drawing 2. When positioned correctly, tighten nut.

- Mount the 100KA pot in the 9/32" hole on the top of the enclosure.

*Bend back and remove the alignment tab on the top of the potentiometer using a pair of pliers before mounting the pot so that it can mount flush against the enclosure surface.*

- Strip and tin a 2 1/2" piece of wire and connect the center-pin of the DC power jack to the sleeve lug of the input jack. **Solder the center pin connection now.**

- Strip and tin a 4 1/2" piece of wire and connect the positive lug of DC power jack to #7. **Solder the positive lug connection now.**

- Locate the battery clip. Connect the red wire to the positive-switch lug of the DC power jack. Connect the black wire to the ring lug of the input jack. **Solder both connections now.**

- Mount the LED footswitch to the 3/4" hole. Be sure to orient the LED leads towards the 100K pot with C on the left and Ab on the right.

*You must remove the button cap with a hex key before mounting. Try to position the switch so that it is closest to the top edge of the hole without leaving any gaps. This is to give enough room for the battery.*

## SECTION 2 – Mount Wires and Selected Components

Please refer to **DRAWING 3**.

- Strip and tin a 2" piece of wire and connect the sleeve lug of the output jack to pin C on the footswitch. **Solder both connections now. Be careful not to put heat on the black plastic divider on the footswitch LED leads.**

- Connect the 1k resistor from lug 4 of the footswitch to the A<sub>b</sub> lead of the footswitch for a blue indicator light. **Solder both connections now. Be careful not to put heat on the black plastic divider on the footswitch LED leads.**

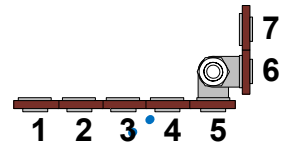

### Input Jack

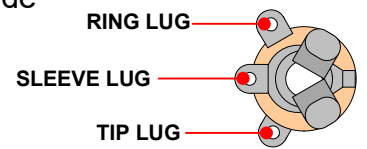

### Output Jack

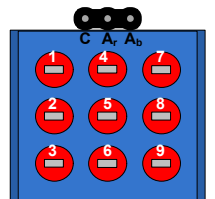
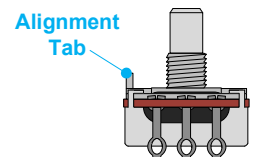
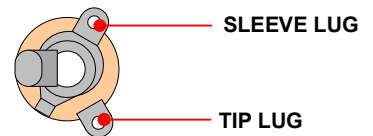

- Strip and tin a 1" piece of wire and connect lug 3 to lug 9 on the footswitch. **Solder both connections now.**
- Strip and tin a 2" piece of wire and connect lug 8 of the footswitch to the output jack's tip lug. **Solder both connections now.**
- Strip and tin a 1 1/2" piece of wire and connect lug 2 of the footswitch to the input jack's tip lug. **Solder both connections now.**
- Strip and tin a 1 1/2" piece of wire and connect lug 3 of the pot to #6. **Solder both connections now.**
- Strip and tin a 5" piece of wire and connect lug 7 of the footswitch to the lug 2 of the pot. **Solder both connections now.**
- Strip and tin a 3 1/2" piece of wire and connect lug 5 of the footswitch to #7. **Solder the connection at lug 5 of the footswitch now.**
- Connect the .047uF capacitor from lug 1 of the pot to #4. Lay the cap flat on the back of the pot. **Solder the connection at lug 1 of the pot now.**

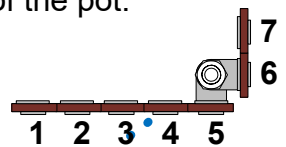
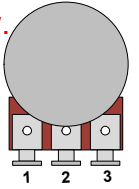
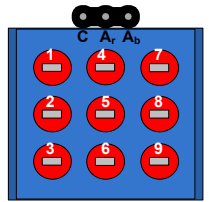

### SECTION 3 – Mount and Connect Remaining Components

Please refer to **DRAWING 4**.

- Connect the 220k resistor from lug 1 of the footswitch to the sleeve lug of the input jack. **Solder the connection at the input jack sleeve now.**
- Cut the white spaghetti sleeve into two 3/4" pieces. Place them on the .0047uF capacitor. Connect the capacitor from lug 1 of the footswitch to #1. **Solder the connection at lug 1 of the footswitch now.**
- Connect the 1.2k resistor from #1 to #3.
- Connect the (+) positive lead of the 47uF capacitor to #2 and the (-) negative to #5.
- Connect the 2.2k resistor from #2 to #5.
- Connect the 22k resistor from #3 to #5. **Solder the connection at #5 now.**
- Connect the 8.2k resistor from #7 to #4.
- Connect the 2N5088 transistor to #2, #3, and #4. Make sure the flat side of the transistor is facing up. The orientation *must* match drawing 4. **Solder connections on #2, #3, and #4 now.**
- Connect the 100k resistor from #1 to #7. **Solder both connections now.**

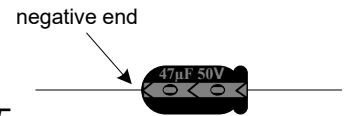

**#2:** Emitter  
**#3:** Base  
**#4:** Collector

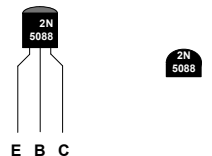

### SECTION 4 – Finishing Up

It's always a good idea to thoroughly double-check your connections before applying power. Attach the knob provided to the potentiometer shaft. Install a 9 volt battery, close the cover using the screws provided (battery not required when using 9v DC power supply). You may find that the battery needs to be positioned carefully to completely close the unit. All batteries may not fit. We find that the Rayovac High Energy is a good fit and reliable battery. You may find others that work well too. Plug a guitar into input jack on right. This turns the unit on. Plug a cable into output jack and plug it into your amplifier.

*-Unplug from the input jack of the unit to turn it off and save power.*

# DRAWING 1

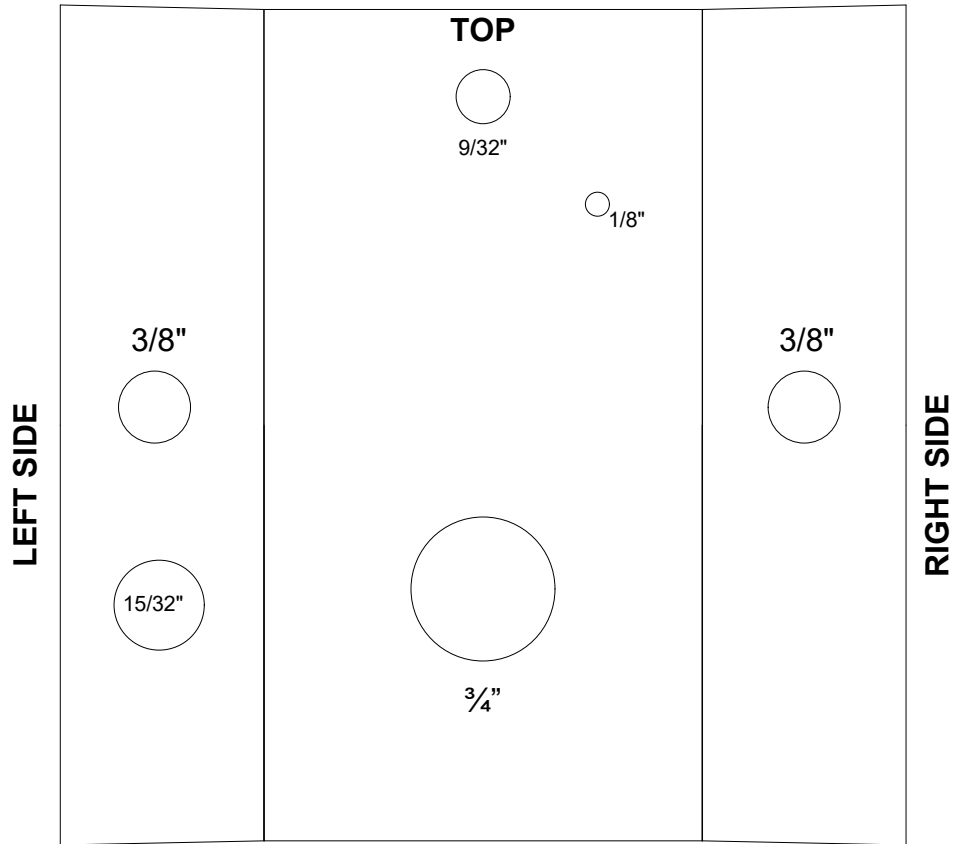

# DRAWING 2

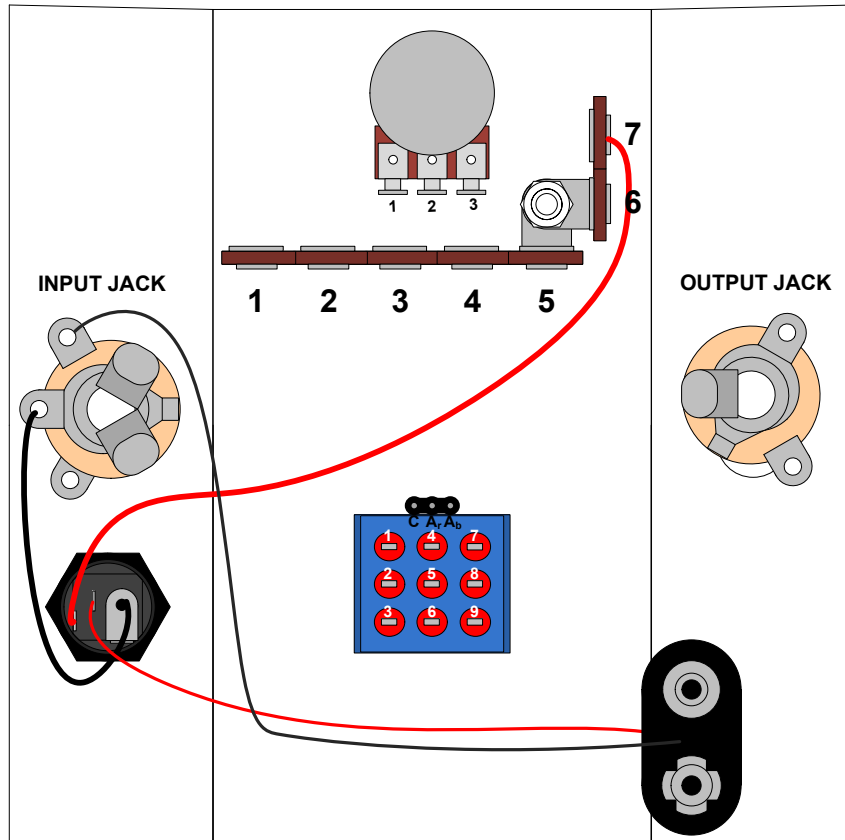



DRAWING 3

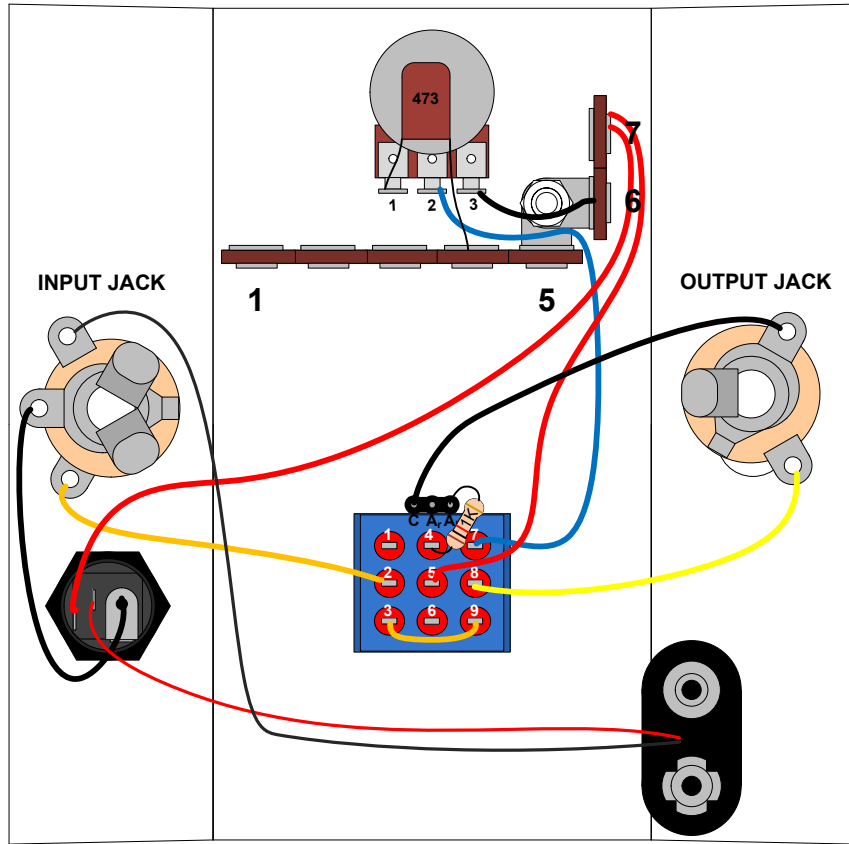

DRAWING 4

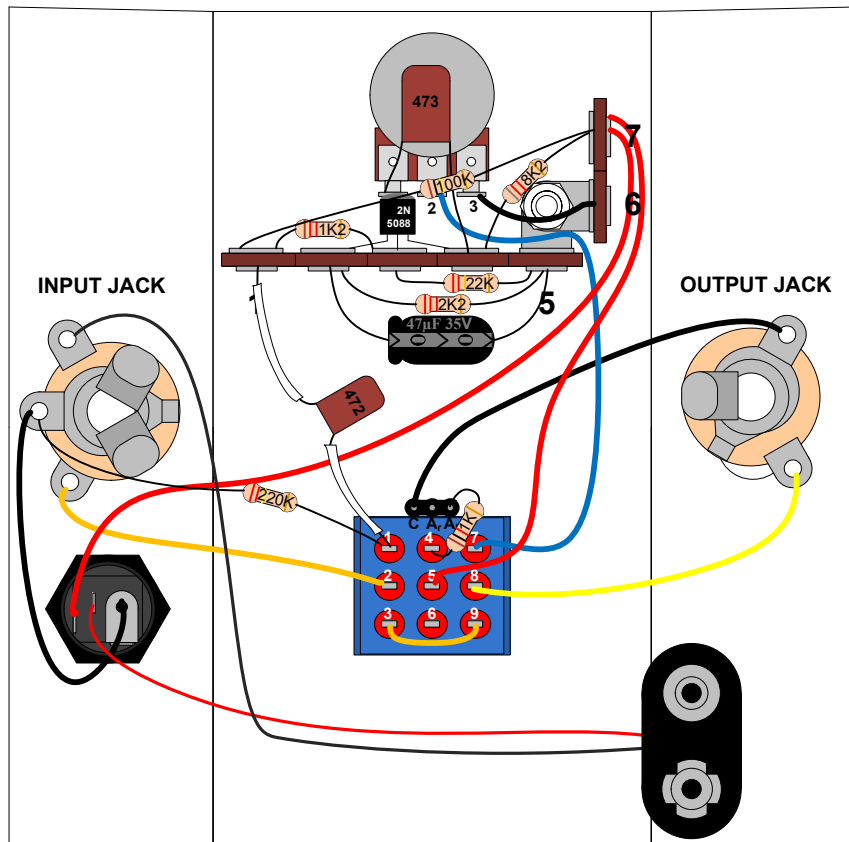

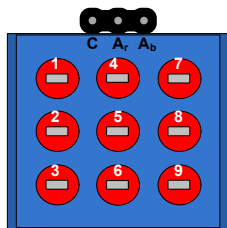
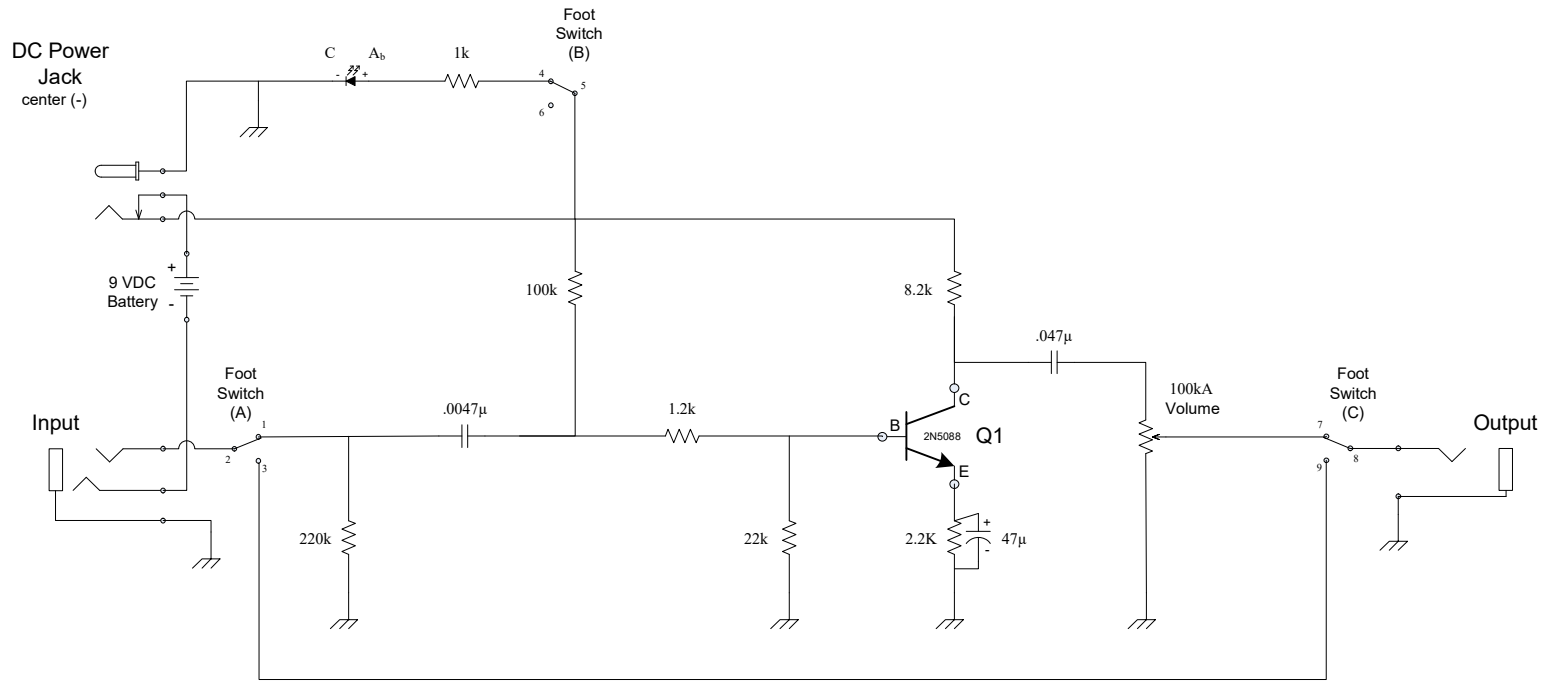

3PDT Foot Switch

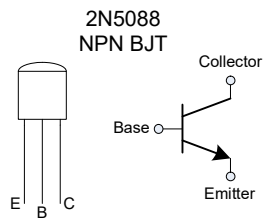

2N5088  
NPN BJT

**MOD**<sup>®</sup>

[www.modkitsdiy.com](http://www.modkitsdiy.com)

Copyright © 2018 by modkitsdiy.com

**"The Penetrator" (K-996)  
Schematic**