

The Contortionist II Troubleshooting Supplement

After thoroughly double-checking your connections, the next step is to take DC voltage measurements to help locate problem areas.

Using a volt meter, connect the ground side lead of the meter to any ground point on the pedal. One ground point would be the input or output jack's sleeve lug. The other volt meter lead will be used to measure DC voltage at the test points listed here.

If you are using only a battery for power, be sure to plug a guitar cable into the input jack when taking measurements. Any major differences from the voltages listed should indicate a problem area.

DC Test Points

Measurement

A (Power Supply)	9.1 VDC
B (Indicator LED Anode)	2.7 VDC
C (Q1 Collector)	1.9 VDC
D (Q1 Base)	1.8 VDC
E (Q1 Emitter)	0.8 VDC
F (Q2/Q3 Collector)	4.3 VDC
G (Q2/Q3 Base)	4.6 VDC
H (Q2 Emitter)	3.9 VDC
I (Q3 Emitter)	5.2 VDC

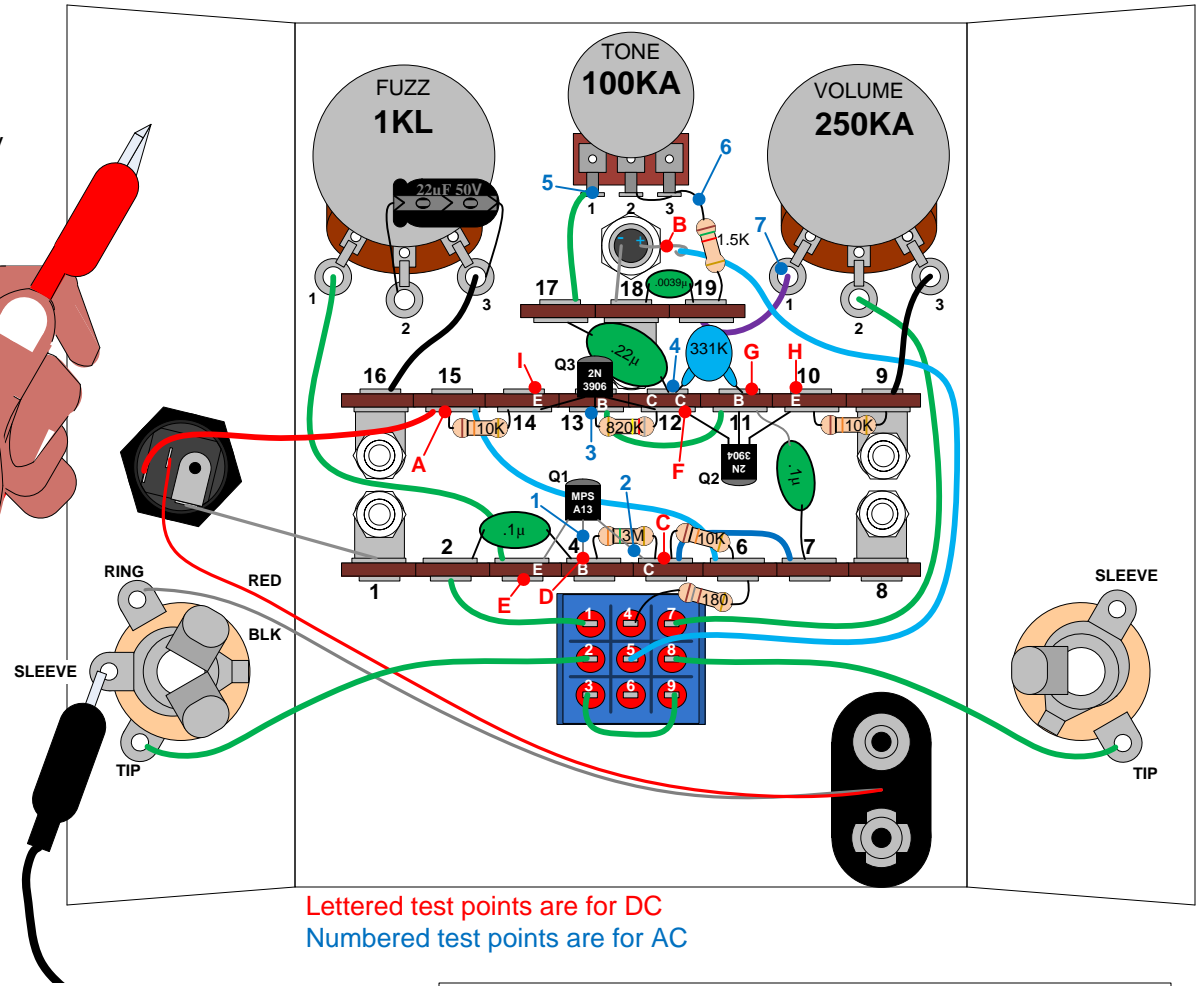
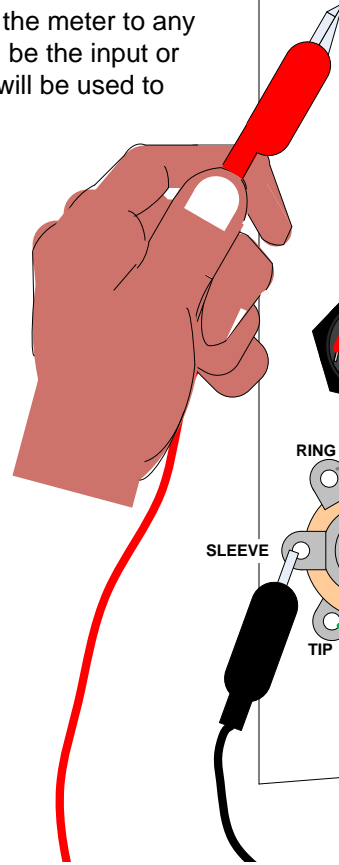

Lettered test points are for DC
Numbered test points are for AC

Measuring AC Voltages from the Guitar Signal

Once your DC voltages are in order, if your kit is still not working properly, you can measure AC voltages along the signal path to troubleshoot further.

You will need a volt meter that can measure the small signal AC voltages that electric guitars put out. The output signal from your guitar will likely be less than 1 V.

First, measure the output signal directly from your guitar. You can do this by plugging your guitar cable into the guitar and leaving the other end of the cable disconnected. Connect your meter across the disconnected ¼" plug's "tip" and "sleeve" sections. Make sure your guitar's volume and tone controls are turned up and strum a chord. When you strum, you should see the AC voltage reading on the meter quickly rise to some maximum value and then fall back to 0 VAC when you stop strumming and the strings are at rest.

Once you are able to measure the output signal from your guitar directly, plug the guitar into the input jack of your kit and use the AC test points to measure the guitar signal along the signal path. Start with test point one and move along in order. You should be looking to identify the last test point where the signal seems normal and the first test point where the signal seems unusual or where it is no longer even present.

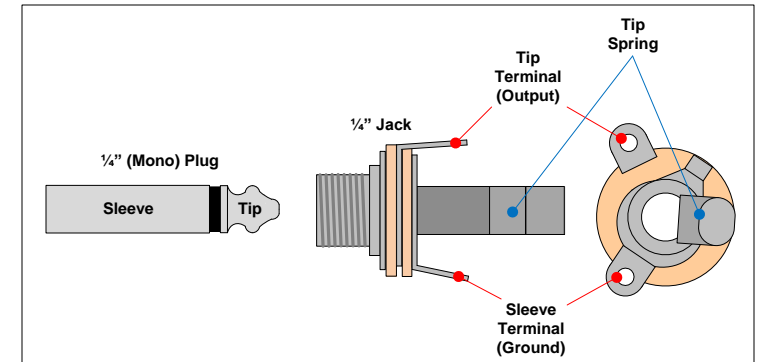

- DC Voltages measured with respect to ground.
- AC Voltages (top) measured with 1KL pot set to max gain. 100KA Tone Set to Max.
- AC Voltages (bottom) measured with 1KL pot set to min gain. 100KA Tone set to Max.

AC voltages measured while strumming an open E chord on a strat with single coil neck pickup (volume and tone turned all the up).

Lettered test points are for DC
Numbered test points are for AC

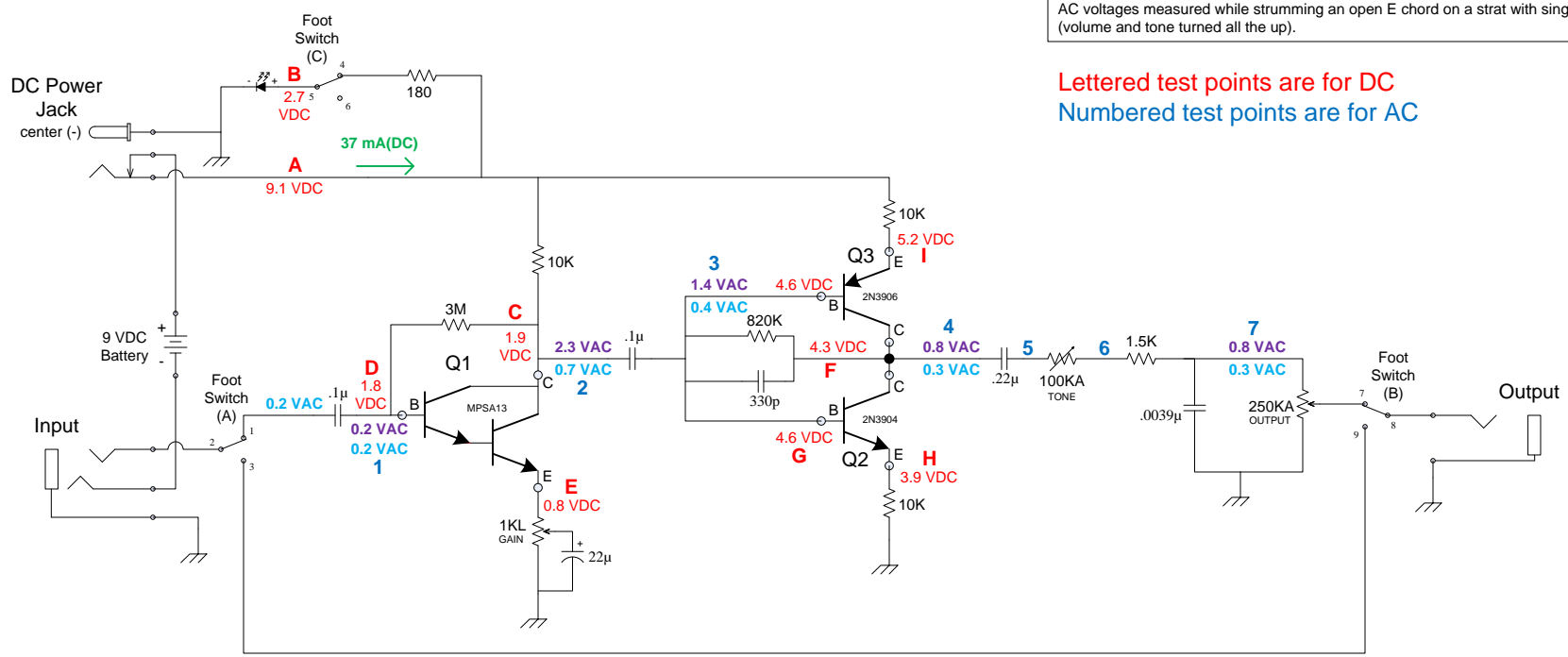

P-H501

3PDT
Footswitch

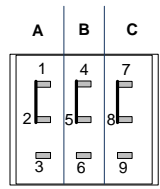

MPSA13

NPN Darlington Transistor

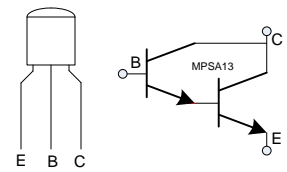

2N3904

NPN BJT

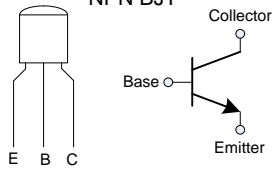

2N3906

PNP BJT

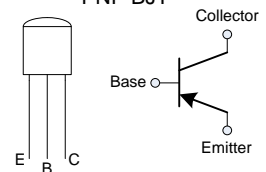

www.modkitsdiy.com
Copyright © 2015 by modkitsdiy.com

**"The Contortionist II" (K-965)
Schematic**